

# PROFILE BOOKLET

## Life Sciences

---

March 2020



Oxford University  
Innovation Limited

---

Buxton Court, 3 West Way  
Oxford OX2 0JB

---

[www.innovation.ox.ac.uk](http://www.innovation.ox.ac.uk)

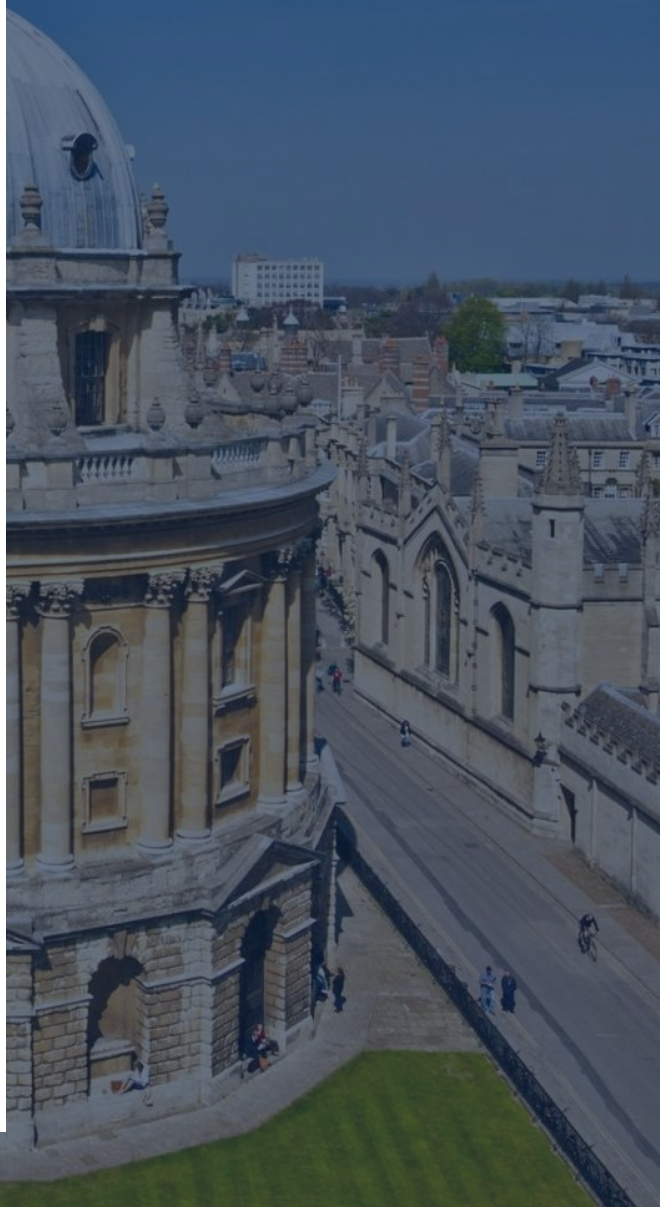

## TABLE OF CONTENTS

<b>AUTOIMMUNE DISEASES .....</b>	<b>1</b>
<b>11088</b> An inhibitor of the complement system derived from tick saliva.....	1
<b>11412</b> Oncostatin-M: a novel therapeutic target for inflammatory bowel disease .....	2
<b>11805</b> Anti-inflammatory drugs from bugs .....	3
<b>13645</b> Complement alternative pathway inhibitor .....	4
 <b>DATA MANAGEMENT TOOLS .....</b>	 <b>5</b>
<b>9663</b> Dynamic Consent .....	5
<b>10332</b> Sortition clinical trial randomisation .....	6
<b>11339</b> The Rare UK Disease Study platform (RUDY).....	7
<b>12664</b> Clinical trial finance management suite .....	8
<b>14422</b> Data acquisition and management system for personalized healthcare .....	9
 <b>DEVICES AND DIAGNOSTICS.....</b>	 <b>10</b>
<b>706</b> Sulphide sensor.....	10
<b>2476</b> Saliva drug testing.....	11
<b>2718</b> Real word arsenic detection .....	12
<b>12309/12313</b> Breath-by-breath respiratory gas analyser .....	13
<b>7895</b> Bacterial identification.....	14
<b>12408</b> Metal-free Catalysts .....	15
<b>12729</b> FieldSense – Next generation tactile feedback systems.....	16
<b>13022</b> Growth prediction of abdominal aortic aneurysms.....	17
<b>13067</b> A Microfluidic Sonication Device for the Production of Coated Microbubbles .....	18
<b>13151</b> Smart mouth guard.....	19
<b>13249</b> Nuclear quadrupole resonance sensors for safer wireless power .....	20
<b>13853</b> Mic-seq: single cells provirus monitoring to inform on HIV cure strategies.....	21
<b>13953</b> Density-of-state based quantum sensitive sensor.....	22
<b>14110</b> Fast-response sensor for oxygen detection in gases and liquids.....	23
<b>14262</b> Magnetic microbubble-conjugation thrombin as a novel drug delivery system .....	24
<b>14654</b> Automated detection of bacterial growth from a photograph of a 96 well plate.....	25
<b>14899</b> Structural functionally graded blast panel for protection against traumatic brain injury.....	26
<b>15519</b> Neuromorphic technology based on new physics.....	27
<b>15595</b> Deep vein thrombosis diagnostic device .....	28
<b>15648</b> A new treatment to predict the growth in abdominal aortic aneurysms.....	29
<b>15823</b> A novel algorithm for biologically inspired lighting solutions.....	30
<b>16143/16372</b> Multifunctional device for focusing light through an optical component .....	31
<b>16735</b> Soil-structure interaction sensor .....	32
<b>16569</b> Rapid method for the measurement of foetal scalp blood pH.....	33

<b>GENOMICS</b> .....	<b>34</b>
<b>10531/15179</b> PubMLST molecular typing database.....	34
<b>14061</b> Chromopainter – Identifying shared ancestry .....	35
<b>14128</b> IMPUTE 4: statistical analysis of genome-wide data .....	36
<b>14253/ 15614/ 15792</b> DNA cloning without sequence constraints and without ‘scar’ sequences .....	37
<b>14526</b> Gap-Seq: single molecule sequencing for single-molecule phenotyping .....	38
<b>14872</b> Sparse decomposition of arrays (SDA) .....	39
<b>15670</b> RELATE: estimating genome wide genealogies for thousands of whole-genome sequences .....	40
<b>IMAGING</b> .....	<b>41</b>
<b>2924/6596</b> Targeted MRI contrast agents for detection of brain tumours and inflammation .....	41
<b>9030</b> Improved inflammation imaging .....	42
<b>9564</b> FSL brain-mapping software .....	43
<b>11771</b> Improved quantification of arterial blood-flow .....	44
<b>11341</b> Smart Align: image registration software for (S)TEM images.....	45
<b>12191</b> Off-resonance correction method for MR perfusion imaging and angiography .....	46
<b>12409</b> Post-processing deblurring for medical imaging .....	47
<b>13299</b> High throughput image analysis platform for 3D cellular tissues.....	48
<b>13366</b> EMNIM: Correlating electron microscopy (EM) and ion mobility (IM) spectra .....	49
<b>14289</b> Correcting imaging artefacts due to bidirectional scanning.....	50
<b>15151</b> Non-invasive PET imaging of PARP expression.....	51
<b>15727</b> Graphene based sensor system compatible with MRI and CT imaging .....	52
<b>16185</b> A new method for automated 3D blood vessel reconstruction .....	53
<b>METABOLIC DISEASES</b> .....	<b>54</b>
<b>8949</b> UKPDS Cardiovascular Risk engine – Version 3.....	54
<b>9797</b> Glycaemic variability calculator .....	55
<b>9965</b> Version 2 of the UKPDS OM – A type 2 diabetes outcomes model .....	56
<b>10766</b> iHOMA2: software for diabetes trials and research .....	57
<b>10804</b> Early gestational diabetes diagnostic .....	58
<b>NEUROSCIENCE</b> .....	<b>59</b>
<b>8818</b> Are you awake? Method for measuring consciousness and depth of anaesthesia.....	59
<b>11128</b> Diagnosing neurological autoimmune disease .....	60
<b>15744</b> Targeted drug delivery to the brain for treating neurodegenerative diseases .....	61
<b>ONCOLOGY</b> .....	<b>62</b>
<b>4130/11532</b> Acute myeloid leukaemia prognostic and diagnostic screening .....	62
<b>6855</b> Brain tumour detection and treatment .....	63
<b>8636</b> New lead compounds for treating cancers involving Ras mutations .....	64
<b>9086</b> Novel cancer treatment to improve the efficiency of radiotherapeutic methods .....	65
<b>11735</b> Prediction method for skin cancer development risk in renal transplant recipients .....	66
<b>12273</b> Stratification method for proximal colorectal cancer patients .....	67
<b>15456</b> IGF2-TRAP: high affinity receptors to sequester growth factors linked to cancer .....	68
<b>15790</b> Preclinical and clinical evaluation of forodesine in patients with leukaemia .....	69

<b>ORTHOPAEDICS .....</b>	<b>70</b>
<b>8573</b> Degradable implant to enhance surgical repair of musculoskeletal tissue .....	70
<b>11194</b> OSSKAR – A positioning device for hands-free stress imaging of the knee .....	71
<b>11652</b> Precision joint alignment for total knee replacement .....	72
<b>11979</b> Medical device facilitating improved patient experience following joint replacement .....	73
<b>12527</b> Improved tools for corrective surgery of the tibia .....	74
<b>13952</b> Targeted imaging agents as a companion diagnostic and prognostic for osteoarthritis.....	75
<b>14859</b> Head extractor tool for total orthopaedic hip replacement.....	76
<b>PRODUCTION/MANUFACTURING .....</b>	<b>77</b>
<b>11475</b> Tissue bioreactor for drug discovery and tissue engineering applications.....	77
<b>14808/14955</b> Increasing the stability and biocompatibility of chemically synthesized oligos.....	78
<b>15101</b> Electrocatalytic nanoparticles (Nafion <sup>®</sup> ) nanostructures doped with redox active species.....	79
<b>15349</b> New method for the characterisation of amorphous complex mixtures .....	80
<b>15513/15608</b> Enhancing crop yield and stress resilience .....	81
<b>15782</b> Single cell isolation .....	82
<b>16771</b> Bespoke reference electrode for electrochemical sensors .....	83
<b>RESEARCH TOOLS.....</b>	<b>84</b>
<b>9192</b> Adaptive animal tracking tags .....	84
<b>10098</b> Nanoparticle detection .....	85
<b>10126</b> IMPACT: Rapid calculation of protein structural parameters.....	86
<b>12970</b> MAGMA: Automated assignment of NMR spectra for proteins and complexes.....	87
<b>13367</b> BiobOx: A flexible tool for structural biology.....	88
<b>12370</b> Protein team assembly for controlling cell signalling and catalysis.....	89
<b>14348</b> SpyTag and SpyCatcher version 2.0 .....	90
<b>14383</b> SnoopLigase for catalysis of ligation between two peptide tags.....	91
<b>15033</b> Electrochemical oxidase test for identifying and quantifying bacteria .....	92
<b>15681</b> Rapid detection of developed viruses and lipid-coated nanoparticles.....	93
<b>SOFTWARE.....</b>	<b>94</b>
<b>12350</b> HTSense: Simplifying the analysis and design of high throughput screens .....	94
<b>14419</b> Quantiphyse - Improved analysis of biomedical imaging data Technology.....	95
<b>14458</b> Motion sickness solution for electronic device use .....	96
<b>14605</b> Improved cross-linking models between amino acids with DynamXL software .....	97
<b>14761</b> Semantic metadata toolkit .....	98
<b>14905</b> AFIRM: Amyloid Formation and Inhibition Mechanism .....	99
<b>16245</b> Virtual Assay drug screening software V3.0 .....	100
<b>TARGETED THERAPIES.....</b>	<b>101</b>
<b>7381</b> Stem cell immunotherapy .....	101
<b>7876</b> Antibiotic.....	102
<b>13048</b> Dendritic cells from iPSCs with an adult phenotype for immunotherapy .....	103
<b>13338</b> A method for precisely tuning gene expression levels in mammalian cells .....	104

**Oxford University Innovation**

Buxton Court, 3 West Way, Botley, Oxford OX2 0JB

T +44 (0)1865 280830 E enquiries@innovation.ox.ac.uk www.innovation.ox.ac.uk

Company No 2199542

Registered Office: University Offices, Wellington Square, Oxford OX1 2JD VAT No 490 7988 85

<b>13916</b>	Inducible CRISPR-TR system for the conditional regulation of gene expression .....	105
<b>13925</b>	Synthetic Cas9-based programmable transmembrane receptors.....	106
<b>14361</b>	Logical control of CRISPR gene editing system .....	107
<b>VACCINES.....</b>		<b>108</b>
<b>7968</b>	S-FLU: Broad spectrum flu protection with a superior safety and delivery profile .....	108
<b>10355</b>	Hepatitis C vaccine.....	109
<b>10599</b>	HIV vaccine .....	110
<b>10924</b>	New class of molecular adjuvant.....	111
<b>11715</b>	Multivalent Dengue vaccine .....	112
<b>13619</b>	Staphylococcus aureus (S. aureus) vaccine .....	113
<b>13769</b>	Zika viral vector vaccine.....	114
<b>COA – CLINICAL OUTCOMES ASSESSMENT.....</b>		<b>115</b>
<b>ALSAQ</b>	The Amyotrophic Lateral Sclerosis Assessment Questionnaire.....	115
<b>CDAQ</b>	The Coeliac Disease Assessment Questionnaire.....	116
<b>DHP-18</b>	The Diabetes Health Profile.....	117
<b>EHP</b>	The Endometriosis Health Profile.....	118
<b>HASMID-10</b>	Health and Self-Management in Diabetes.....	119
<b>LUNTERS</b>	The Liverpool University Neurologic Side Effects Rating Scale .....	120
<b>MAAQ</b>	Mathematics Attitudes and Anxiety Questionnaire .....	121
<b>MCQ</b>	The Mild Cognitive Impairment Questionnaire .....	122
<b>MFPDI</b>	The Manchester Foot Pain and Disability Index .....	123
<b>MIDAS</b>	The Myocardial Infarction Dimensional Assessment Scale .....	124
<b>MOxFAQ</b>	The Manchester-Oxford Foot Questionnaire .....	125
<b>MSK-HQ</b>	Musculoskeletal Health Questionnaire .....	126
<b>OCS</b>	The Oxford Cognitive Screen.....	127
<b>ODQ</b>	The Oxford Depression Questionnaire .....	128
<b>OES</b>	The Oxford Elbow Score .....	129
<b>OHS</b>	The Oxford Hip Score .....	130
<b>OKS</b>	The Oxford Knee Score.....	131
<b>OKS-APQ</b>	Oxford Knee Score –Activity and Participation Questionnaire.....	132
<b>OSIS</b>	The Oxford Shoulder Instability Score.....	133
<b>OSS</b>	The Oxford Shoulder Score .....	134
<b>OxAFQ-C</b>	The Oxford Ankle Foot Questionnaire for Children .....	135
<b>Ox-PAQ</b>	The Oxford Participation and Activities Questionnaire .....	136
<b>PDQ</b>	The Parkinson’s Disease Questionnaire .....	137
<b>PDQ-C</b>	Parkinson’s Disease Questionnaire – Carers.....	138
<b>ReQoL</b>	Recovering Quality of Life Questionnaire .....	139



# AUTOIMMUNE DISEASES

# An inhibitor of the complement system derived from tick saliva



**Available to license:** A novel peptide from ticks that inhibit the complement system of the innate immune system at the C5 step of the cascade.

Oxford researchers have developed a peptide derived from tick saliva and it targets the C5 step of the complement cascade.

The complement system is part of the immune system which is thought to have a small contribution to overall immunity. Irregular function of the complement system results in serious diseases that can be debilitating. Despite the overall strong interest from pharmaceutical companies, only two drug inhibitors have been approved.

Ticks are known for feeding on the blood of humans and animals. During blood feeding they secrete a wide range of proteins to maintain haemostasis, prevent inflammation, prevent a host immune response and block angiogenesis. The secreted proteins are pharmacologically useful, since they have certain very stable qualities.

## A new approach

Researchers at Oxford have focused on identifying the complement system inhibiting proteins found in tick saliva. The complement system acts as a first line of defence against parasites, such as ticks. What the Oxford team found was a ~50 amino acid peptide which is a highly soluble, chemically and proteolytically stable potent inhibitor of the complement system.

The team has identified a specific step which complements inhibition and allows the peptide to act as the C5 node. There are only two approved drugs for the inhibition of the complement system and one of them (a monoclonal antibody) is widely known as 'the most expensive drug' on the market with an approximate cost

of £330,000 per year, per patient. The Oxford inhibitor peptide targets the same C5 node of the complement inhibitor but it is an 50-mer peptide that can be expressed in simple bacterial hosts enabling low cost manufacture.

## Licensing opportunity

The Oxford invention is protected by a UK priority application. Isis is seeking for an industrial partner to license, develop, and bring this therapeutic opportunity to the market.



**For further information please contact:**

**Dr Bob Fishleigh**

**[bob.fishleigh@innovation.ox.ac.uk](mailto:bob.fishleigh@innovation.ox.ac.uk)**

**+44 (0)1865 614429**

**[www.innovation.ox.ac.uk](http://www.innovation.ox.ac.uk)**

**Project number: 11088**

## Technology Transfer from the University of Oxford

The information in this Project Profile is provided "as is" without conditions or warranties and Oxford University Innovation makes no representation and gives no warranty that it is the owner of the intellectual property rights in the technology described.

# Oncostatin-M: A novel therapeutic target for inflammatory bowel disease



Oxford researchers have discovered a novel target that could lead to a whole new class of effective inflammatory bowel disease drugs being developed.

Inflammatory bowel disease (IBD) is a term that encompasses a group of diseases, including Crohn's disease and ulcerative colitis, which affect the colon and small intestine. These are debilitating chronic disorders affecting more than 300,000 people in the UK. Patients with IBD suffer periodically with mild to severe symptoms with intermittent remission. There is currently no cure, and so treatments traditionally focus on managing the symptoms by hindering the immune response that drives the disease. Traditionally treatments include anti-inflammatory drugs, but these lack specificity and cause gastrointestinal toxicity.

## The current 'gold-standard' therapy

Modern treatments, such as monoclonal antibodies against Tumour Necrosis Factor- $\alpha$  (TNF $\alpha$ ), induce and sustain remission by targeting components of inflammatory pathways that are thought to be more specific to IBD. However 40% of patients subjected to this therapeutic regimen do not respond, and up to a further 60% of those that initially respond fail to respond to repeat treatments. These patients are left unable to control their IBD and will eventually require surgery. Anti-TNF $\alpha$  therapy is the current gold-standard treatment for patients with IBD but alongside their low response rate, they also cause immunosuppression. Therefore, there is an obvious need for new therapeutics to treat IBD.

## Targeting a solution

Researchers at Oxford University have identified a potential new target for IBD therapeutics; they found Oncostatin-M (OSM) to be a major component of the cytokine response in the Th17 inflammatory pathway. This pathway is thought to be critical in the pathogenesis of IBD, therefore targeting OSM or its receptor may offer a more effective treatment for a greater proportion of IBD patients.

Additionally, the researchers found that levels of OSM may indicate whether a patient has IBD and whether a patient in remission will have a recurrence of symptoms. Furthermore, the level of OSM correlated with patient response to anti-TNF $\alpha$  therapy and so could be used to determine the most appropriate first-line treatment for IBD and other TNF $\alpha$ -mediated conditions.

Altogether, this research has discovered novel methods to diagnose, prognose and treat IBD which could revolutionise the care of patients suffering from the disease.

## Commercialisation

Oxford University Innovation has filed a patent (PCT/GB2016/050185) on this technology. The associated publication can be accessed here: <https://www.nature.com/articles/nm.4307>

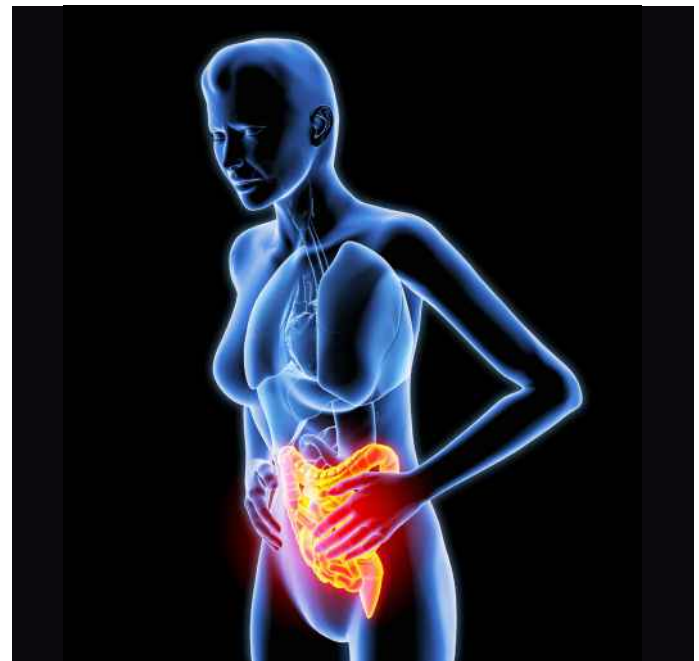

**For further information please contact:**  
**Dr Matt Carpenter**  
[matthew.carpenter@innovation.ox.ac.uk](mailto:matthew.carpenter@innovation.ox.ac.uk)  
**+44 (0)1865 280970**  
[www.innovation.ox.ac.uk](http://www.innovation.ox.ac.uk)  
**Project number: 11412**

## Technology Transfer from the University of Oxford

The information in this Project Profile is provided "as is" without conditions or warranties and Oxford University Innovation makes no representation and gives no warranty that it is the owner of the intellectual property rights in the technology described.



**Available to license:** Oxford University researchers have cloned, expressed, and characterised 31 anti-inflammatory peptides derived from ticks.

## Targeting chemokines

Inflammation plays a central role in a number of common and debilitating diseases such as rheumatoid arthritis (RA) and inflammatory bowel disease (IBD), in common and fatal infection such as influenza cytokine storm but also in rare, fatal diseases such as myocarditis, idiopathic pulmonary fibrosis (IRF) and inflammatory breast cancer.

Chemokines drive inflammation and immunity by activating the migration of innate and adaptive immune cells to disease tissues. The chemokine network (46 chemokines, 24 G-protein receptors) is complex, with each chemokine typically binding multiple receptors, each receptor binding multiple chemokines, and multiple receptors present on individual immune cells.

Therapies that target single chemokines or receptors often fail as these targets form a robust network, with multiple chemokines typically overexpressed in disease. For instance, 27/46 chemokines are expressed in RA, 16/46 in IBD, 13/46 in myocarditis, 24/46 in IPF and 9/46 in influenza cytokine storm.

## Novel salivary evasins

Ticks have evolved small salivary peptides (Evasins) that suppress chemokine-driven inflammation by acting as “ligand traps” - binding and neutralising multiple chemokines. Using a novel yeast display technology, Oxford University researchers have cloned, expressed, and characterised 31 novel salivary evasins from 8 tick species. These novel evasins bind multiple chemokines with low nM affinities (determined by high-throughput biolayer interferometry), and can neutralise chemotaxis by target chemokines, (demonstrated using high-content video microscopy of chemokine-receptor expressing cell lines).

Each evasin binds and neutralises a distinct subset of chemokines; certain evasins can neutralise complex mixtures of chemokines. The complete pharmacological characterisation of the novel evasins is underway to identify evasins or their combinations that can functionally neutralise the combinations of chemokines typically found in diseased tissues.

These preliminary pharmacological studies will underpin the application of these novel evasins in inflammatory diseases. Collaborations have been established for pre-clinical and clinical studies in RA and myocarditis, IBD, influenza cytokine storm, IPF and breast cancer.



For further information please contact:  
**Dr Christine Whyte**  
[christine.whyte@innovation.ox.ac.uk](mailto:christine.whyte@innovation.ox.ac.uk)  
**+44 (0)1865 280921**  
[www.innovation.ox.ac.uk](http://www.innovation.ox.ac.uk)  
**Project number: 11805**

## Technology Transfer from the University of Oxford

The information in this Project Profile is provided "as is" without conditions or warranties and Oxford University Innovation makes no representation and gives no warranty that it is the owner of the intellectual property rights in the technology described.

# Complement alternative pathway inhibitor



**Available to license:** A novel polypeptide isolated from tick saliva that inhibits the alternative complement pathway

Researchers at Oxford have identified and applied for a patent in respect of a novel tick-derived polypeptide inhibitor of a key step in the alternative pathway, which represents an important therapeutic target for a number of complement-mediated diseases.

In recent years the involvement of the complement system in a range of human diseases has been elucidated and the first drugs that inhibit specific parts of the complement cascade have reached the market, with a number of others undergoing clinical development.

Prominent amongst the marketed complement inhibitors is Alexion Pharmaceuticals' Soliris® (eculizumab), a monoclonal antibody that is registered for the treatment of paroxysmal nocturnal hemoglobinuria (PNH) and atypical haemolytic uremic syndrome, and which recorded net product sales of over US\$2.6bn in 2015.

This and other complement inhibitors are currently being investigated clinically in the treatment of conditions including age-related macular degeneration, chronic obstructive pulmonary disease, myasthenia gravis, graft-versus-host disease, delayed graft function, and neuromyelitis optica spectrum disorder, and many other potential therapeutic applications have also been identified.

## A new approach

Researchers at Oxford have identified a novel polypeptide inhibitor of a key step in the alternative complement pathway that is contained in the saliva of a certain species of tick. The polypeptide is chemically and proteolytically stable and is readily soluble. The polypeptide is the subject of a UK priority patent application that includes composition-of-matter claims.

Tick-derived polypeptide inhibitors of the complement system have attracted significant research interest and one, Akari Therapeutics' Coversin, has displayed positive preliminary results in an ongoing clinical trial investigating its use in the treatment of PNH in eculizumab-resistant patients.

## Licensing opportunity

Oxford University Innovation is now seeking a commercial partner to develop further and bring to market this new alternative pathway inhibitor for the treatment of conditions such as age-related macular degeneration under an appropriate licence agreement.



**For further information please contact:**  
Dr Bob Fishleigh  
[bob.fishleigh@innovation.ox.ac.uk](mailto:bob.fishleigh@innovation.ox.ac.uk)  
+44 (0)1865 614429  
[www.innovation.ox.ac.uk](http://www.innovation.ox.ac.uk)  
Project number: 13645

## Technology Transfer from the University of Oxford

The information in this Project Profile is provided "as is" without conditions or warranties and Isis Innovation makes no representation and gives no warranty that it is the owner of the intellectual property rights in the technology described.



# DATA MANAGEMENT TOOLS

Oxford researchers have developed a personalised, web-based interface for the advanced management of fully informed consent. Designed for situations where consent preferences are fluid but of critical importance to the delicate relationship between the researchers and participants. The system is being piloted for biobanks, personalised medicine and conventional clinical trials.

## The challenge of retention

Recruitment and retention of participants for research is critical. Poor participant retention rates can be attributed to paper-based systems; particularly obtaining, recording, and auditing consent. Inefficient paper-based systems yield high costs. A plethora of bespoke, opaque and poorly supported electronic systems exist but these do not facilitate adaptive designs and changing research protocols. Since, for example, 45% of clinical trials require costly extensions, the inability to effectively engage participants and obtain consent is highly detrimental. Biobanks and translational genomics must also support new demands and emergent findings.

## A patient-centric approach

This participant-centric approach provides an interface that ensures patients can give, review and change their consent preferences whilst allowing two-way interactions between study management and participants. Participants are therefore fully engaged with the process, retention rates are increased and management costs reduced.

Benefits of the Dynamic Consent approach to trial management include:

- Easy collection, storage and retrieval of consent preferences
- On-going communication for improved recruitment, participant engagement and reduced drop-out rates
- Easy identification of participants that can be approached for additional trials
- Enables adaptive study designs through a simple re-consenting procedure
- Legally compliant data collection that is efficient and secure

Benefits to participants include:

- Enhanced interaction and on-going participation due to easy access to information
- Information delivered according to an individual's preferences
- Fully informed and prepared for each stage of the trial
- Enabling, as able to review and revise consent preferences
- Suitable for visually impaired, and those with hearing or learning difficulties
- Secure

## Commercialisation

For further information on gaining access to Dynamic Consent, please contact the Oxford University Innovation Technology Transfer Manager.



**For further information please contact:**  
**Dr Richard Auburn**  
[richard.auburn@innovation.ox.ac.uk](mailto:richard.auburn@innovation.ox.ac.uk)  
**+44 (0)1865 280956**  
[www.innovation.ox.ac.uk](http://www.innovation.ox.ac.uk)  
**Project number: 9663**

## Technology Transfer from the University of Oxford

The information in this Project Profile is provided "as is" without conditions or warranties and Oxford University Innovation makes no representation and gives no warranty that it is the owner of the intellectual property rights in the technology described.

## Available to license: Clinical trial randomisation system

A stand-alone, online randomisation system builder that supports the standard randomisation and minimisation algorithms for both open and blind studies. The tool incorporates full auditing, user management, email notifications, treatment resource management, reporting and monitoring.

### Why randomise?

Randomisation is an essential tool for clinical and life science researchers. For example, in a clinical trial, subjects in the control and treatment groups should not differ in any systematic way or the results will be biased. For instance, if a greater proportion of older subjects are assigned to the treatment group, then the outcome of treatment may be influenced by this imbalance. Researchers therefore need to control for factors such as age, sex, pre-existing medical conditions and treatments (such as medication), as well as other factors such as smoking/non-smoking, alcohol consumption, fitness, etc.

A second layer of randomisation is then required to avoid selection bias when allocating patients to a treatment or control group. This can occur if there is any knowledge as to which group a patient is being assigned to, and again may affect the results. It is therefore important that allocation is concealed from the system.

### Randomisation strategies

Clearly, randomisation in clinical trial settings is unfortunately not as simple as tossing a coin. A wide range of statistical methods (e.g. simple, block, stratified, and covariate adaptive methods) have been developed to allow proper and effective randomisation, each with their own advantages and disadvantages, and often complex to apply.

### A simple, flexible and scalable approach

Sortition puts a complete and easy-to-use study randomisation toolkit in the hands of the clinical researcher, meaning it no longer needs to fall within the remit of a highly skilled statistician. The system comes complete with secure user management, a full audit trail, email notifications and all the reporting and monitoring tools you would expect. Sortition is currently in use in a growing number of trials, with over 1,400 patients randomised to date.

### Key advantages

- Clean, uncluttered interface
- Accessible over the internet
- Wide range of powerful randomisation and minimisation methods
- Works for both open and blind studies
- Fully customisable and scalable
- Full audit trail
- Secure user management
- Email notifications
- Built-in treatment resource management, reporting and monitoring tools



For further information please contact:  
**Dr James Groves**  
[james.groves@innovation.ox.ac.uk](mailto:james.groves@innovation.ox.ac.uk)  
**+44 (0)1865 614425**  
[www.innovation.ox.ac.uk](http://www.innovation.ox.ac.uk)  
**Project number: 10332**

## Technology Transfer from the University of Oxford

The information in this Project Profile is provided "as is" without conditions or warranties and Oxford University Innovation makes no representation and gives no warranty that it is the owner of the intellectual property rights in the technology described. 6

# The Rare UK Diseases Study platform



Oxford University researchers have developed an online patient driven research platform to capture reported outcome measures and events within a dynamic consent framework.

## Challenges in healthcare

One of the many challenges in healthcare is the lack of information about the disease history and conditions of patients over long periods of time. This is especially the case for chronic and rare diseases. Patients with these diseases may have mobility issues and live geographically far from hospitals and clinical research centres, making it difficult for them to pay frequent visits to these institutions. Furthermore, patients with milder symptoms may be neglected because they are not compelled to seek help at secondary and tertiary care settings. These challenges, if not addressed, can cause a failure in detecting early signals of life-threatening diseases and impede clinical research.

## RUDY

Oxford researchers have developed an online Rare UK Diseases Study (RUDY) platform which brings together several unique features distinct from many other systems, such as online registration, dynamic consent and participant entry of data.

Patients can securely register online and provide verbal consent over the phone. Once registered and consented, patients can have access to a customisable profile page, scheduled questionnaires and other bespoke content, such as an interactive skeleton for recording the patients' fracture history.

The highlights of the platform:

- Enables secure encryption of all patient identifiable information
- Designed with the users in mind
- Built in a framework that allows easy addition of functionality
- Operates through dynamic consent

- Allows patients to access their own data anywhere, anytime
- High patient recruitment and retention rate

RUDY is currently implemented online at <https://research.ndorms.ox.ac.uk/rudy/> for patients with rare disease – those affecting the bone, joints and/or blood vessels. Currently, RUDY has 615 participants and a total of 6750 questionnaires completed.

This platform not only relieves the burden on the clinical team and lower the administration costs for patient recruitment but also encourages the collaboration between patients, clinicians and researchers to improve healthcare.

## Commercialisation

Oxford University Innovation is interested in speaking with companies or institutions that would like to implement this system to support patient data management.



Homepage of the RUDYstudy.org website.

**For further information please contact:**  
**Dr Richard Auburn**  
[richard.auburn@innovation.ox.ac.uk](mailto:richard.auburn@innovation.ox.ac.uk)  
**+44 (0)1865 280956**  
[www.innovation.ox.ac.uk](http://www.innovation.ox.ac.uk)  
**Project number: 11339**

## Technology Transfer from the University of Oxford

The information in this Project Profile is provided "as is" without conditions or warranties and Oxford University Innovation makes no representation and gives no warranty that it is the owner of the intellectual property rights in the technology described.

**Available to license:** Software for financial management of clinical trials.

An administrative employee of the University of Oxford has developed a unique and comprehensive tool for managing clinical trials finance within the UK regulatory regime.

## Clinical trial finance suite

The clinical trial finance suite has successfully been used for 5 years in a clinical trial unit with up to 60 active trials and over £1M annual turnover.

Finance management is a vital part of successful clinical trials. The environment is often complicated due to the mandatory regulatory and reporting regime that defines the methodology for costing of trials and cost attribution and reporting requirements that no off the shelf accounting package could support.

### A comprehensive tool

The suite allows detailed costing for:

- Set-up costs, per-patient costs and pass-through costs
- Categorising between procedures and investigations according to the Department of Health guidance using a reference table of costs
- Staff timings in categories of doctor, nurse and tech admin
- Attributing costs to research, treatment or service support following ACORD procedures
- Including the Standard of Care comparators as required in NHS R&D assessment
- Mirroring the layout of the UKCRN commercial costing template so that negotiation with commercial entities is facilitated
- Allowing 'providers' and 'funders' to be set at the lowest element of cost to facilitate accurate accounting of payments for service providers and bill funding sources

### An accounting tool

The suite collates patient information, creates invoice requests and allows multifaceted reports, including:

- Generating the cost needed for trial grant funding applications and ensuring sufficient funding is in place before the trial starts
- Reporting on actual costs by staff type, investigation type to enable comparison with the forecasted budget for work teams or service units

- Reporting the detail activity by funding stream to enable reclaim
- Calculating cost attribution reports to enable NHS R&D approval at the host trust
- The production of itemised patient activity and progress as backing to invoice to trial sponsor, coping with multiple funders on each project

### Effective and efficient

The management software automatically produces data routing, validation and scripting system for costing, invoicing and reporting to save processing time and reduce manual data entry. It automatically prompts and generates reminders to smooth the running of a multi project clinical trial unit. The software is based on the Filemaker platform and can be used on both Apple Mac and PC computers.

### Portfolio reporting ability

Reporting is possible slicing data through any attribute and for any time period:

- **Costs:** forecasted vs actual
- **Activities:** recruitment against target, patient visits
- **Staff management:** staff costs recovered vs actual salary
- Income and expenditure reports by trial, PI grouping for any period as desired,
- Invoice status
- Customisable reports
- Trial unit stats and performance indicators

**For further information please contact:**

**Dr Paul Cogswell**

[paul.cogswell@innovation.ox.ac.uk](mailto:paul.cogswell@innovation.ox.ac.uk)

+44 (0)1865 280856

[www.innovation.ox.ac.uk](http://www.innovation.ox.ac.uk)

Project number: 12664

## Technology Transfer from the University of Oxford

The information in this Project Profile is provided "as is" without conditions or warranties and Oxford University Innovation makes no representation and gives no warranty that it is the owner of the intellectual property rights in the technology described.

# Data Acquisition and Management System for Personalised Healthcare



A comprehensive collection of software tools to support the input of electronic personalised information and the subsequent integration, management and usage of clinical and laboratory data.



Personalised medicine aims to identify the most suitable treatment for an individual, for example, by providing a customised treatment based on a patient's genome sequence. This approach has been used to diagnose and treat patients with cancer and rare diseases.

## Genome analysis platform

Genome medicine is becoming an accepted approach as the costs of next-generation sequencing have reduced and a network of genomic medicine centres have been established throughout the United Kingdom. Simultaneous analysis of clinical and genomic data can help identify the genetic causes of a disease to support diseases diagnosis, explain why a treatment has not worked and identify a new therapeutic route for a patient. Meta-analysis of these large datasets are expected to revolutionise clinical research by prompting new insights into both rare and common diseases. However, due to the volume and complexity of these datasets - a comprehensive data acquisition and management system is required to streamline data collection, integration and management.

Oxford researchers have created a collection of software tools that allow clinicians and researchers to integrate data originating from various sources and databases, organise the data in a systematic way and then extract

useful information to support clinical care and research.

The system confers the following benefits:

- takes advantage of state-of-the-art knowledge in computer and data sciences to deliver an efficient and reliable service
- embodies a flexible approach to software design allowing for run-time configuration of forms and versioning of data schemas
- custom-written for hospitals and clinical laboratories dealing with big data on a regular basis
- efficacy has been validated in practice and at scale

## Commercialisation

Oxford University Innovation is interested in hearing from organisations that would like to implement their own data acquisition and management system for hospitals, clinical laboratories and partner organisations.

**For further information please contact:**  
**Dr Richard Auburn**  
[richard.auburn@innovation.ox.ac.uk](mailto:richard.auburn@innovation.ox.ac.uk)  
**+44 (0)1865 280956**  
[www.innovation.ox.ac.uk](http://www.innovation.ox.ac.uk)  
**Project number: 14422**

## Technology Transfer from the University of Oxford

The information in this Project Profile is provided "as is" without conditions or warranties and Oxford University Innovation makes no representation and gives no warranty that it is the owner of the intellectual property rights in the technology described.





# DEVICES AND DIAGNOSTICS

Oxford researchers have developed an electrochemical sensor that has been developed that measures the concentration of hydrogen sulphide ( $H_2S$ ) or thiols in fluids.

Hydrogen sulphide ( $H_2S$ ) is a noxious and highly toxic gas. It is formed as a by-product in numerous chemical processes and can be generated through the decomposition of organic matter (e.g. sewage effluent).

Additionally, hydrogen sulphide is present in crude oil, thereby creating a risk to workers in the petroleum industry who may be exposed to unacceptably high levels of this gas. It is therefore important in many industrial processes that monitoring procedures are in place to determine the concentrations of  $H_2S$  present in the environment.

## Sulphide sensors

Figure 1 shows a schematic view of the Oxford electrochemical sensor. The sensor is exposed to the sulphide/thiol-containing fluid, which may enter the device across a permeable membrane (34). The fluid subsequently passes through two porous blocks (32 & 36), which contain an immobilised reagent that renders the sulphide/thiol-containing fluid conductive.

A potential is applied between electrodes 40 and 44, and the flow of current between electrodes 40 and 42 is measured. The current reading is then de-convoluted to provide the concentration of sulphide/thiol. Critically, immobilisation of the reagent in the electrochemical component (36) of the sensor enables miniaturisation of this technology, which leads to faster response times, lower consumption of reagents and lower unit costs.

## Patent status

This technology is protected by several international patents and Isis would like to talk to companies interested in exploiting the above ground use of this sensing technology. Please contact the Oxford University Innovation Project Manager to discuss this further.

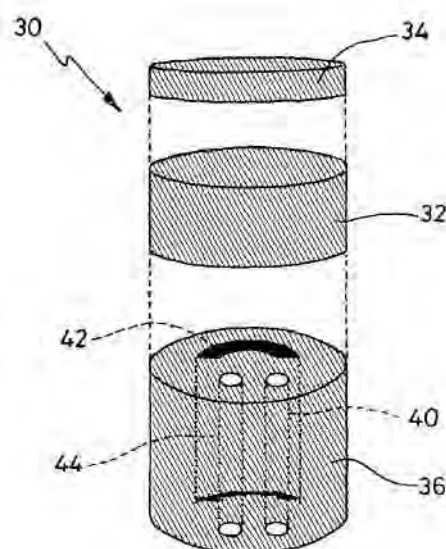

Figure 1

For further information please contact:

Dr Andrew Bowen

[andrew.bowen@innovation.ox.ac.uk](mailto:andrew.bowen@innovation.ox.ac.uk)

+44 (0)1865 614449

[www.innovation.ox.ac.uk](http://www.innovation.ox.ac.uk)

Project number: 0706

## Technology Transfer from the University of Oxford

The information in this Project Profile is provided "as is" without conditions or warranties and Oxford University Innovation makes no representation and gives no warranty that it is the owner of the intellectual property rights in the technology described.

Researchers at Oxford University have developed a hand-held device for rapid, quantitative saliva drug testing.

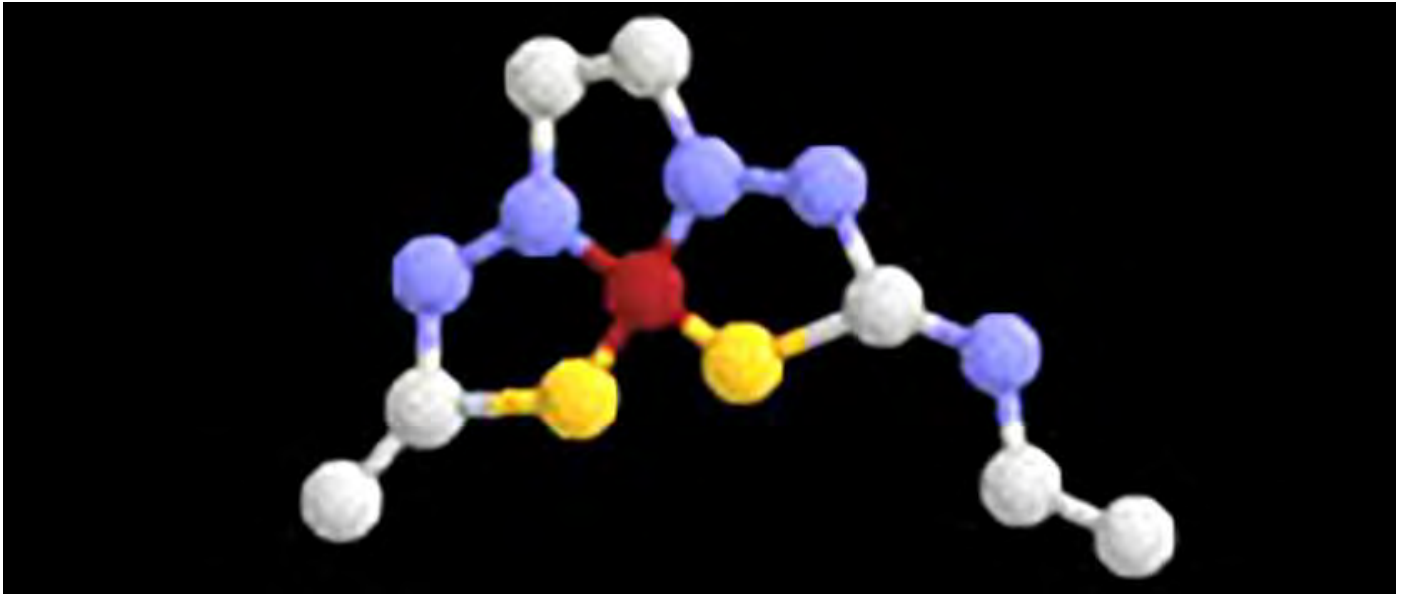

## Early detection

The prevalence of driving while affected by drugs is rising. It has been shown that drugs are detected commonly among those involved in motor vehicle accidents, with studies reporting up to 25% of accident-involved drivers testing positive for illicit drugs with cannabis being the most common. It is apparent that drugs in combination with alcohol, and multiple drugs, present an even greater risk and it has been concluded that drug driving is a significant problem, both in terms of a general public health issue and as a specific concern for drug user.

The challenge to further progress in this area is the development of a hand held device, which will enable not only qualitative drug testing, but also quantitative testing.

## A better process for collection

The Oxford Invention provides a method for creating a hand-held device for rapid, accurate, quantitative, saliva drug testing.

Unlike currently available hand-held saliva drug testing equipment, the Oxford Invention:

- Is highly sensitive
- Does not require laboratory confirmation of positive tests
- Is not pH dependent
- Provides accurate results in less than 60 seconds
- Is ideally suited for on the spot checks, for example roadside testing

## Commercialisation

Oxford University Innovation Ltd. has filed a priority patent application, which covers this technology and is seeking partners to aid in its exploitation.

**For further information please contact:**  
**Dr Chandra Ramanujan**  
[chandra.ramanujan@innovation.ox.ac.uk](mailto:chandra.ramanujan@innovation.ox.ac.uk)  
**+44 (0)1865 614434**  
[www.innovation.ox.ac.uk](http://www.innovation.ox.ac.uk)  
**Project number: 2476**

## Technology Transfer from the University of Oxford

The information in this Project Profile is provided "as is" without conditions or warranties and Oxford University Innovation makes no representation and gives no warranty that it is the owner of the intellectual property rights in the technology described.

# Real world arsenic detection



Researchers at the University of Oxford have developed electrochemical techniques to detect low levels of arsenic in the presence of copper.

Arsenic is a naturally occurring element widely distributed in the earth's crust and a common contaminant of drinking water.

Exposure to arsenic can cause a variety of adverse health effects, including dermal changes, respiratory, cardiovascular, gastrointestinal, genotoxic, mutagenic and carcinogenic effects. Arsenic contamination of drinking water has been reported globally with dangerously high levels present in for example Argentina, Bangladesh, Cambodia, Chile, China, Ghana, Hungary, Inner Mongolia, Japan, Mexico, Nepal, New Zealand, Philippines, Taiwan, the United States and Vietnam.

The World Health Organization's recommended maximum arsenic contamination level for drinking water is 10 ppb. A practical issue when addressing arsenic contamination in the real world (as opposed to the academic laboratory) is the large variation in arsenic contamination levels in wells only a few metres apart.



**More than 56 million Americans could be drinking tap water containing average levels of arsenic that pose unacceptable cancer risks (source: US NRDC)**

Laboratory based analytical procedures have previously been developed to allow detection of low levels of arsenic contamination. The development of reliable electrochemical methods suitable for the development of low cost hand-held test instruments has been hampered by the presence of other contaminants (lead, copper, zinc, iron, antimony, bismuth, selenium, silver and mercury) in real world water samples.

The presence of copper as Cu(II) is the most common source of interference and has to date prevented the development of instruments for use in field testing.

## The Oxford invention

Using novel modified glassy carbon electrodes electrochemical techniques have been developed which allow determination of low levels of arsenic contamination even in samples containing high levels of Cu(II) as a co-contaminant.

This invention will enable the development of new low-cost testing devices with high sensitivity that can be directly applied in the field.

For further information please contact:  
Dr Chandra Ramanujan  
[chandra.ramanujan@innovation.ox.ac.uk](mailto:chandra.ramanujan@innovation.ox.ac.uk)  
+44 (0)1865 614434  
[www.innovation.ox.ac.uk](http://www.innovation.ox.ac.uk)  
Project number: 2718

## Technology Transfer from the University of Oxford

The information in this Project Profile is provided "as is" without conditions or warranties and Oxford University Innovation makes no representation and gives no warranty that it is the owner of the intellectual property rights in the technology described.

## Researchers at the University of Oxford have developed an in-line gas analysis system

#  
U  
h  
u  
u

### Current technology falls short of the mark

Traditional methods used to analyse breath gas concentration rely on off-line analysis. For example, the Douglas bag method, where expired air is collected over a period of up to 60 seconds and subsequently analysed. Modern approaches have attempted to solve this issue, however, the process of redirecting expired gased to an analyser using a t-piece still results in a disconnect between the flow measurement (in-line) and the gas analysis (off-line). This means that a calibration step is required to ensure that these two parameters are temporally aligned.

### A breath of fresh air

Researchers at the University of Oxford have developed an in-line gas analysis technology capable of calculating  $O_2$  and  $CO_2$  concentration and gas flow concurrently. The device uses laser spectroscopy to measure directly the concentration of oxygen, carbon dioxide and water vapour in the breathing tube. The invention allows the calculation of gas exchange occurring at the lungs when both inspiratory gas compositions and flow rates are varying.

Not only does this remove the sampling issue, but the device has been clinically tested and is highly accurate with a volume accuracy of  $\pm 0.2\%$  and  $O_2/CO_2$  concentration accuracies of around  $\pm 0.5\%$ .

We believe the key advantages of the Oxford technology

- Highly accurate flow and gas concentration
- In-line analysis using a face-mask unit
- Clinically tested and verified
- Further functionality to assess lung function is being

### Patent protection

This technology is covered by a portfolio of granted UK, yo -y \ y @



For further information please contact:

Dr Richard Reschen

[richard.reschen@innovation.ox.ac.uk](mailto:richard.reschen@innovation.ox.ac.uk)

+44 (0)1865 280872

[www.innovation.ox.ac.uk](http://www.innovation.ox.ac.uk)

Project number: 12313, 12309, 3672

## Technology Transfer from the University of Oxford

The information in this Project Profile is provided "as is" without conditions or warranties and Oxford University Innovation makes no representation and gives no warranty that it is the owner of the intellectual property rights in the technology described.

# Bacterial identification



**Available to license:** Rapid, universal bacterial identification system.

Database and scheme for the fast, accurate classification of bacteria, with applications including disease diagnosis.

## Universal gene-based identification

High-resolution bacterial characterisation is essential in microbiology, particularly for disease diagnosis, where rapid and precise identification is a high priority.

Gene-based methods have become increasingly important in bacterial classification, complementing and to an extent replacing more traditional phenotypic methods. However, until now, there has been no single system which works for all bacteria.

Scientists at the University of Oxford have developed a universal identification scheme based on ribosomal multilocus sequence typing (rMLST). This represents the first genotypic scheme that can provide both broad and accurate characterisation of bacteria at all phylogenetic levels.

The system works through the identification and analysis of allelic variation within the ribosomal protein subunit (rps) genes, which are universal yet record a wide range of evolutionary diversity, to effect rapid and highly accurate phylogenetic identification.

## Benefits of the Oxford system

- Reliable identification
- High resolution
- Results at push of a button
- One system for all bacteria

## Supporting data

A web-accessible and expandable database comprising genome data from more than 2000 bacterial isolates has been generated. The variation of 53 rps genes is catalogued in this database, providing a means of defining the precise phylogenetic position of any bacterial sequence at the domain, phylum, class, order, family, genus, species and strain levels.

## Applications

The data generated for the rMLST scheme could be used in combination with next-generation sequencing to enable the rapid identification of bacterial isolates at the push of a button. Equally the database enables the development of PCR-based, species or strain-specific diagnostic tests.

Applications include:

- Population studies
- Epidemiological investigations
- Diagnostic tests

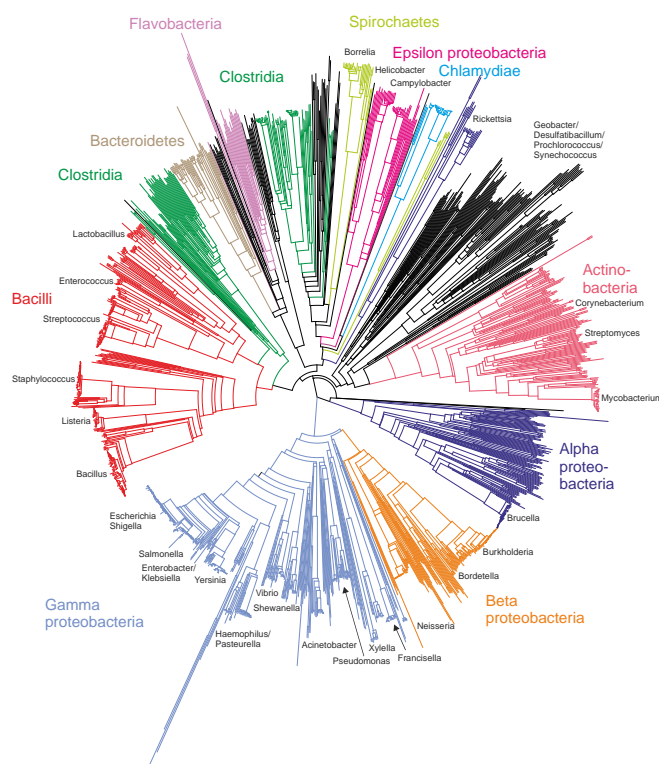

**Above image:** Neighbour-joining tree of the entire bacterial domain, reconstructed from concatenated ribosomal protein gene sequences.

**For further information please contact:**  
**Dr Matthew Carpenter**  
[matthew.carpenter@innovation.ox.ac.uk](mailto:matthew.carpenter@innovation.ox.ac.uk)  
**+44 (0)1865 280970**  
[www.innovation.ox.ac.uk](http://www.innovation.ox.ac.uk)  
**Project number: 7895**

## Technology Transfer from the University of Oxford

The information in this Project Profile is provided "as is" without conditions or warranties and Oxford University Innovation makes no representation and gives no warranty that it is the owner of the intellectual property rights in the technology described.

Oxford scientists have developed a novel class of metal-free catalysts based on Frustrated Lewis Pair chemistry, which offer excellent activity and selectivity in industrially applicable hydroboration and dehydrogenation reactions.

## Transition-metal catalysis

Transition-metal catalysts are extensively used in large-scale industrial processes in the pharmaceutical industry. The use of homogeneous catalysts for such transformations offers a number of advantages, including excellent activity and selectivity under mild conditions, and in the presence of sensitive or reactive functional groups.

The ability to readily tune the reactivity of the metal-centre through selection of the appropriate ligands is also a major factor in the diverse range of applications that have been found for such catalysts.

Transformations facilitated by transition-metal catalysts underpin the majority of synthetic routes to pharmaceutically active compounds.

## Towards a sustainable future

Despite the evident advantages of using transition metal catalysts in synthesis, there are issues with cost, toxicity, and sustainability. Some of the most widely used homogeneous catalysts are based on metals that will potentially become unavailable in the next 30 years, as commercially viable deposits become exhausted.

Many transition-metals are toxic, and regulatory controls require their removal from pharmaceutical products. This adds a step to the production process, and therefore additional cost. Sustainable, non-toxic alternatives are, therefore, of significant interest to the industry.

## A new class of metal-free catalysts

Oxford researchers have developed a new class of metal-free catalysts, offering excellent activity in selective hydroboration and dehydrogenation reactions. The reactivity of the catalysts is based on "Frustrated Lewis Pair" chemistry, and offers the following features:

- Metal-free system
- Highly tuneable reactivity

- Selective hydroboration under mild conditions
- Tolerant to sensitive functional groups
- Low catalyst-loadings
- Modular design to fit a range of applications

The Oxford compounds also demonstrate activity in C-H bond activation under mild conditions and the potential to activate a range of small molecules, such as CO<sub>2</sub> and CO. The dehydrocoupling reactions can also be used to produce polymers with inorganic backbones, offering applications in electronic devices.

## Commercialisation

The compounds and applications thereof, are the subject of a UK priority patent application with the potential for international coverage. The activity of the catalysts towards hydroboration and dehydrogenation has been extensively tested and work is ongoing to uncover the full potential of this new class of molecules. Oxford University Innovation is seeking industrial partners to support commercialisation of this technology.

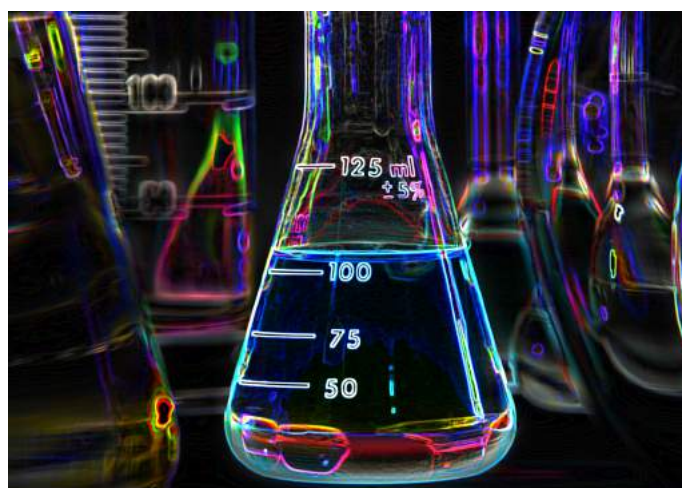

For further information please contact:

Marina Fuentes Sainz

[marina.fuentessainz@innovation.ox.ac.uk](mailto:marina.fuentessainz@innovation.ox.ac.uk)

+44 (0)1865 614423

[www.innovation.ox.ac.uk](http://www.innovation.ox.ac.uk)

Project number: 12408

## Technology Transfer from the University of Oxford

The information in this Project Profile is provided "as is" without conditions or warranties and Oxford University Innovation makes no representation and gives no warranty that it is the owner of the intellectual property rights in the technology described.

# FieldSense – Next generation tactile feedback systems



Oxford researchers have developed FieldSense, a haptic feedback technology based on the precise placement of magnetic nodes.

## Simulating senses

The sense of touch is critical to how we perceive the world around us. It helps us discover and classify new objects, as well as alerting us to change in the environment. Over the last 30 years, haptic technologies have sought to provide more immersive experiences by engaging our sense of touch. This has resulted in developments such as tactile electronic displays, virtual reality gaming and interactive medical devices.

## Touching the limits

Current haptic technologies focus on the use of vibrational or electronic stimuli. Vibrations are neither specific nor directional meaning that they struggle to provide precise and detailed feedback. Electronic or “shock” stimuli are more precise, but depending on the magnitude of the stimulus, it could be uncomfortable or even painful for the user.

## FieldSense - An attractively simple magnetic solution

Researchers at the University of Oxford have developed FieldSense, a haptic technology, which uses affordable, simple arrays of magnetic nodes to generate precise and rapid tactile feedback.

The stimuli provided by field sense can be tailored to the purpose meaning that it could bring haptic technologies into new applications, as an alternative to more widely used electric stimuli.

The main advantages of the technology are as follows:

- Low cost and simple to implement
- Low power usage
- Controllable stimulus
- Pain-free feedback method

## Patent Protection

The FieldSense technology is subject to a UK patent application and Oxford University Innovation Ltd. is seeking partners to aid in its commercialisation.



**For further information please contact:**  
**Dr Chandra Ramanujan**  
[chandra.ramanujan@innovation.ox.ac.uk](mailto:chandra.ramanujan@innovation.ox.ac.uk)  
**+44 (0)1865 614434**  
[www.innovation.ox.ac.uk](http://www.innovation.ox.ac.uk)  
**Project number: 12729**

## Technology Transfer from the University of Oxford

The information in this Project Profile is provided "as is" without conditions or warranties and Oxford University Innovation makes no representation and gives no warranty that it is the owner of the intellectual property rights in the technology described.



# Growth prediction of abdominal aortic aneurysms



Researchers at the University of Oxford have developed a method for determining the predictive rate of growth of abdominal aortic aneurysms (AAA).

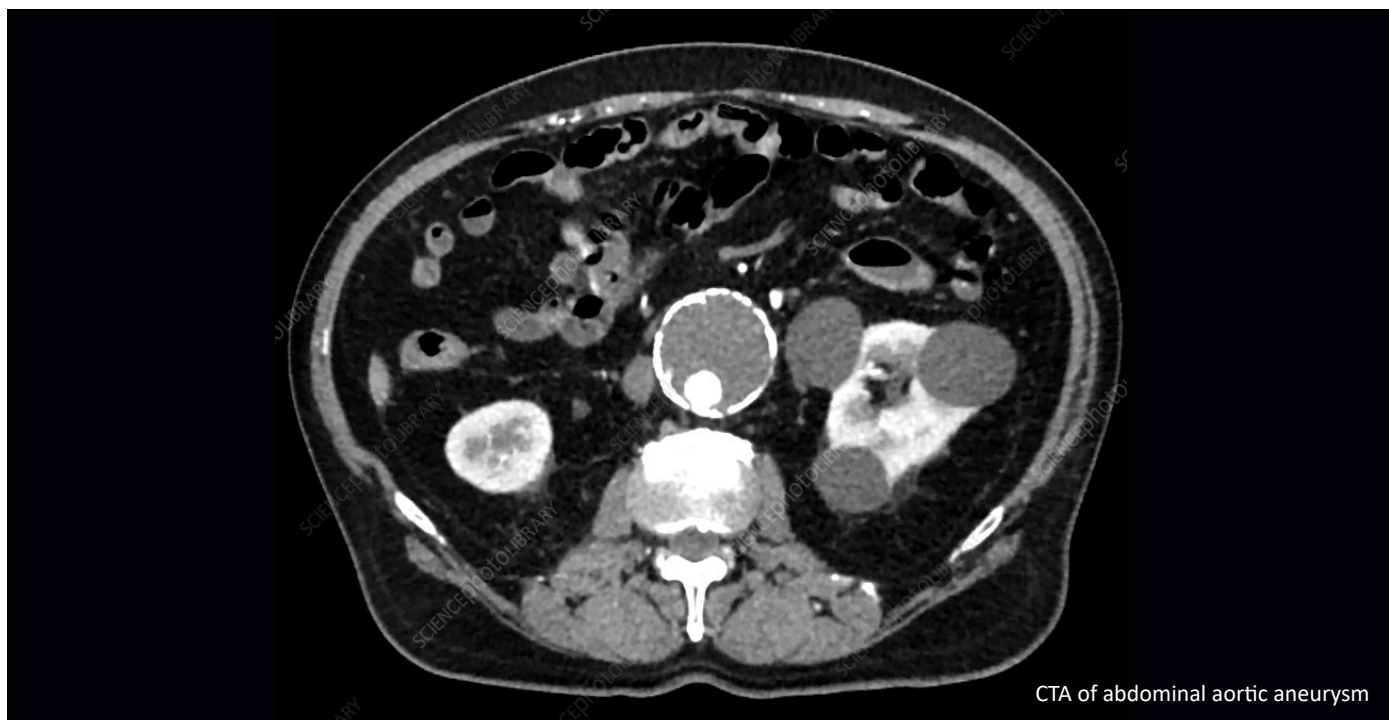

## What is an abdominal aortic aneurysm?

The aorta is the main blood vessel that carries blood from the heart to the rest of the body. An abnormal expansion in the abdominal region of the aorta is called an abdominal aortic aneurysm (AAA). When an AAA continues to expand, there is an increased risk of it bursting and this can lead to internal bleeding and in many cases, death. Ruptured AAAs kill approximately 200,000 people in the world each year and of these, 6000 are in the UK.

To prevent AAA ruptures, AAA screening programmes have been implemented in the UK, Sweden, Australia, and Germany – with other countries to follow. In the NHS alone, more than 100,000 ultrasound scans are performed each year for AAA surveillance. However, many of these scans are redundant if we are able to predict the growth of the AAA.

AAAs can be treated by surgery but usually this only occurs when an aneurysm reaches a certain size

(>5.5cm). It has been shown that aneurysm size alone may not be an absolute predictor of the risk of rupture. Furthermore, the rate of AAA progression may vary significantly between individuals and the growth rate of an AAA is a good indicator as to whether surgical intervention is required.

In a recent international survey of vascular surgeons, developing novel methods for the prediction of AAA growth was voted as the top priority for research in AAAs. The method developed by the Oxford team is the first step towards personalised management for patients with AAAs.

**For further information please contact:**  
**Dr Dinali de Silva**  
[dinali.desilva@innovation.ox.ac.uk](mailto:dinali.desilva@innovation.ox.ac.uk)  
**+44 (0)1865 614441**  
[www.innovation.ox.ac.uk](http://www.innovation.ox.ac.uk)  
**Project number: 13022**

## Technology Transfer from the University of Oxford

The information in this Project Profile is provided "as is" without conditions or warranties and Oxford University Innovation makes no representation and gives no warranty that it is the owner of the intellectual property rights in the technology described.

# A Microfluidic Sonication Device for the Production of Coated Microbubbles



**Available to license:** A novel way of producing microbubbles which have many applications, particularly in the field of medicine.

The Oxford Team has developed a platform technology that could be used in a clinical setting to produce microbubbles employed as contrast agents in ultrasound imaging or as drug delivery vehicles.

## Gas-filled microbubbles

Gas-filled microbubbles stabilised by a surfactant or polymer coating are routinely used in medical imaging as ultrasound contrast agents, being capable of enhancing ultrasound backscatter from blood by several orders of magnitude. Furthermore, the microbubble shell can be employed as a scaffold for transporting biologically active compounds or targeting agents in the circulation, which has opened the way for the use of microbubbles as vehicles in therapeutic applications such as drug delivery or gene therapy. However, the acoustic response and therefore the clinical utility of microbubbles are profoundly influenced by their physical characteristics, including size, size distribution, and the mechanical properties of the coating layer. Therefore, there is a need for a system which offers tighter control over microbubble properties to maximise their clinical effectiveness.

## Manufacture of microbubbles

For the majority of applications, microbubbles are currently fabricated using standard emulsification methods such as sonication which results in highly heterogeneous microbubble populations in terms of size, surface properties, and stability/dynamic response and loading of e.g. drugs for therapeutic applications. Over the past 10 years microfluidic devices have been explored as an alternative but whilst these offer excellent control over microbubble size, they suffer from low production rates, short device life time, and poor control over microbubble surface properties.

## Advantages of the Oxford system

Compared to conventional methods, the Oxford approach offers the advantage of higher control over the properties of the physical environment in which microbubble formation occurs, allowing for improved reproducibility between experiments and narrower microbubble size distribution.

As well as being easy to operate, the system also offers superior device lifetime and low fabrication costs.

Furthermore, the parameters in the system can be finely adjusted in order to optimise the characteristics of the finished product, such as microbubble size, size distribution and concentration, and physical properties of the microbubble shell which are key determinants of microbubble stability and response to ultrasound.

Oxford University Innovation is looking to speak with parties interested in developing or licensing this technology. The technology is subject to a patent application.

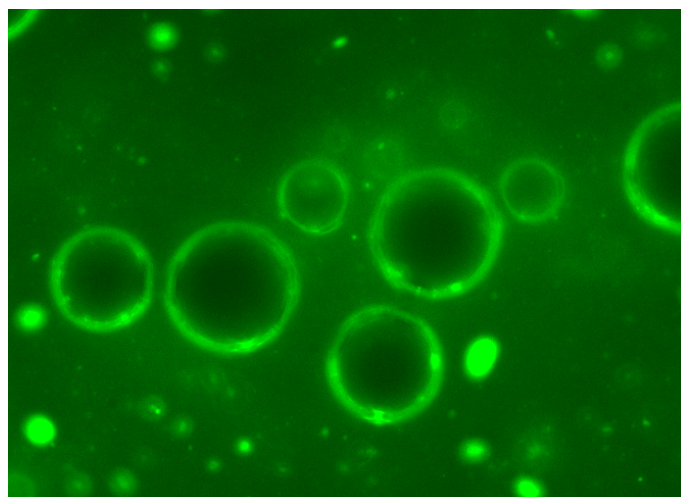

For further information please contact:

Dr Dinali de Silva

[dinali.desilva@innovation.ox.ac.uk](mailto:dinali.desilva@innovation.ox.ac.uk)

+44 (0)1865 614441

[www.innovation.ox.ac.uk](http://www.innovation.ox.ac.uk)

Project number: 13067

## Technology Transfer from the University of Oxford

The information in this Project Profile is provided "as is" without conditions or warranties and Isis Innovation makes no representation and gives no warranty that it is the owner of the intellectual property rights in the technology described.

# Smart mouth guard



Researchers based at Oxford University have developed a smart mouth guard, which allows the wearers to monitor and track their performance and physical exertion on the field.



## Participation nation

In 2016, around 16 million adults in England were engaged in sporting activities on a weekly basis, with contact sports such as Rugby, seeing an increase of up to 25% compared to the previous year (Active People Survey). Having the correct protective equipment is crucial to ensure the safety of these inherently dangerous pursuits. For example, mouth guards are used to protect wearers' teeth and help prevent concussions, with approximately 40 million mouth guards being sold in the US every year.

## Performance monitoring

At both an elite and amateur level there is a desire for sports people to gather data on their health and performance. In 2016 alone, around 80 million sports wearable units were sold worldwide. Smart watches and heart monitors have led the way in this regard, however there has been little work on providing intelligent protective equipment.

## Smart mouth guard

Oxford researchers have developed a smart mouth guard that not only offers protection but also allows the

wearers to monitor and track their sports performance without wearing an extra, bulky device. The mouth guard measures several physical parameters and transfers the information wirelessly to a mobile device. We believe the main benefits of the device to be as follows:

- Discrete and easily used
- Measures several parameters simultaneously
- Data analysis software provided
- Detects perceived and actual fatigue
- Prevents injuries through digital and physical means

## Commercialisation

This technology is subject to a patent application. Oxford University Innovation would like to speak to companies who are interested in commercialising this technology.

**For further information please contact:**  
**Dr Chandra Ramanujan**  
[chandra.ramanujan@innovation.ox.ac.uk](mailto:chandra.ramanujan@innovation.ox.ac.uk)  
**+44 (0)1865 614434**  
[www.innovation.ox.ac.uk](http://www.innovation.ox.ac.uk)  
**Project number: 13151**

## Technology Transfer from the University of Oxford

The information in this Project Profile is provided "as is" without conditions or warranties and Oxford University Innovation makes no representation and gives no warranty that it is the owner of the intellectual property rights in the technology described.

# Nuclear quadrupole resonance sensor for safer wireless power



Oxford researchers have developed an innovative safety solution that uses nuclear quadrupole (NQR) resonance to detect biological material within the wireless power transfer (WPT) magnetic field.

## Charging ahead without wires

The global sales of electric vehicles are expected to top 1 million for the first time in 2017 (Frost & Sullivan, 2017) and with this increased demand comes a need for a more convenient and efficient method of recharging on-board batteries. Wireless charging is an attractive solution, as it reduces the amount of input required from the vehicle owner and eliminate cumbersome leads and charging stations.

Current wireless charging systems are typically based on inductive charging, where a magnetic field is generated between a coil located on the ground and one in the vehicle. Fields generated in this way generally exceed 85 kHz.

## Wireless power transfer safety

There is a widely perceived danger with wireless power transfer (WPT), that humans or animals could step into the generated magnetic field while the device is in use. It is a requirement that such systems do not expose users or animals to harmful levels of electromagnetic radiation and that it adheres to guidelines set out by the International Commission on Non-ionising Radiation Protection (ICNIRP). In order to prevent this, effective “trip switches” are needed, where the power can be cut in the presence of biological material.

## Nuclear quadrupole resonance

Researchers at the University of Oxford have developed a sensor, based on nuclear quadrupole resonance (NQR), capable of detecting biological material in proximity to the WPT field. The NQR system differentiates between humans or animals and can provide feedback to the WPT device to trigger a shut-down when necessary. The power can then be restored once the biological material is clear of the field.

We believe the main benefits of the Oxford solution are as follows:

- Lower cost and more reliable than current radar solutions
- Differentiation between different biological material
- Fewer false positives than other safety devices
- Easily integrated into existing WPT systems
- Allows WPT manufacturers to adhere to ICNIRP guidelines

## Patent protection

A patent has been filed that covers this technology. Oxford University Innovation Ltd. is keen to talk to anyone who could aid in the commercialisation of this device.

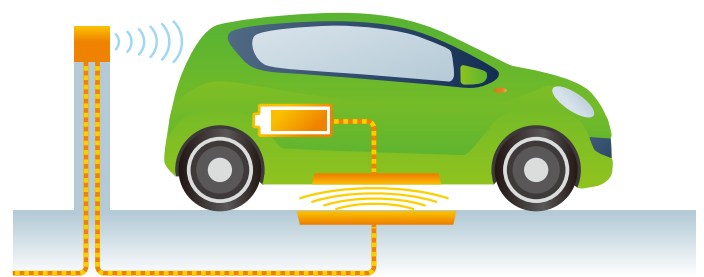

**For further information please contact:**  
**Adrian Coles**  
[adrian.coles@innovation.ox.ac.uk](mailto:adrian.coles@innovation.ox.ac.uk)  
**+44 (0)1865 614432**  
[www.innovation.ox.ac.uk](http://www.innovation.ox.ac.uk)  
**Project number: 13249**

## Technology Transfer from the University of Oxford

The information in this Project Profile is provided "as is" without conditions or warranties and Oxford University Innovation makes no representation and gives no warranty that it is the owner of the intellectual property rights in the technology described.

# Mic-seq: single cells provirus monitoring to inform on HIV cure strategies



Researchers at the University of Oxford have developed a novel method for isolating, characterising, and quantifying the very rare cells that comprise the HIV reservoir



## The HIV cure barrier

Currently, there are 36.9 million people worldwide living with HIV. Whilst antiretroviral therapy (ART) can reduce the viral load of infected individuals to undetectable levels, total HIV eradication remains challenging due to dormant integrated copies of the viral genome in host cells. This latent reservoir allows the virus to re-establish infection on stopping ART, and represents the key target to achieve HIV cure.

Quantifying and characterising this reservoir is critical to monitoring new therapies, defining clinical trial end-points and discovering new drug targets. Given the inability of current technologies to isolate and assess this very rare population of cells, there exists a need to address this important research gap.

## Single cell microfluidics

By employing microfluidic technologies, Oxford University researchers have developed a revolutionary technique to isolate latent HIV+ cells, and crucially, to retain their associated nucleic acids for downstream analysis. The technique relies upon the generation of water-in-oil droplets (WOs) that encapsulate single cells which are accompanied by PCR reagents and a fluorescent probe that - critical to latency assays - fluoresces only in the presence of HIV proviral DNA, and not RNA.

After PCR, the WO's are either encapsulated in water-in-oil-in-water droplets (WOWs) that are amenable to sorting via flow-cytometry (i.e. HIV+ and HIV- populations), or directly sorted on an additional microfluidic device developed by the group.

The platform has multiple applications, and in particular, the retention of nucleic acids after lysis, allows for a variety of downstream assessments.

The benefits of this invention include:

- Providing the ability to isolate, sort, and quantify the extremely rare population of latent cells
- Quantification may allow for patient stratification for clinical trials
- To characterise the reservoir from enriched populations may assist in the development of new therapeutics targeting these rare cells
- Combining the sensitivity of PCR based methods with single cell diagnostics and isolation of associated nucleic acids
- The potential to combine the technology with commercial flow cytometry, offers the potential to combine nucleic acid and proteomic signals
- Opens up a new area of research against HIV, with options to explore remission and cure
- The ability to apply this technology to any clinical condition typified by very rare cell populations eg Oncology, Haematology, Rheumatology, Immunology, amongst others.

## Commercialisation

Oxford University Innovation Ltd. is seeking discussions with companies interested in licencing this technology.

**For further information please contact:**

**Dr Philippa Christoforou**

**philippa.christoforou@innovation.ox.ac.uk**

**+44 (0)1865 280842**

**www.innovation.ox.ac.uk**

**Project number: 13853**

## Technology Transfer from the University of Oxford

The information in this Project Profile is provided "as is" without conditions or warranties and Oxford University Innovation makes no representation and gives no warranty that it is the owner of the intellectual property rights in the technology described.

# Density-of-state based quantum sensitive sensors



Scientists at Oxford University and São Paulo State University have developed a highly sensitive, label-free density-of-states (DOS) based sensing technology operating at the mesoscopic or nanoscale level.

## Limitations of current technologies

The ability to detect concentrations that are in the picomolar ( $10^{-12}$ ) range have proved incredibly challenging. Due to the limitations of the current technologies these challenges include:

- Most techniques aren't sensitive to a range of functional chemical groups
- The signal received from un-labelled biological material can be too weak to be amplified
- Samples require labelling with either an antibody or fluorescent marker to amplify the signal which is costly and prone to error

## Electrochemical disruptive technology

Scientists at Oxford University and São Paulo State University have developed a highly sensitive sensor using nanoscale electrochemical disruptive technology. This technology, originally developed for biomedical sensing, detects the change to the potential upon binding of a molecule to an electroactive surface, which is then amplified to allow the detection of picomolar to micromolar concentrations of the item of interest. The device itself is constructed in such a way that allows it to be incorporated into existing Complementary Metal-Oxide Semiconductor (CMOS)-based instruments.

## Potential applications

The device can detect molecules that are a few atoms in size, up to those as large as proteins but could also be used to detect electromagnetic radiation. The technology can be adapted to detect specific chemical functional groups. This adaptability enables the device to perform in many different applications such as:

- Point of care medical tests for specific biological markers, using microliter volumes of human fluids

- Chemical detection of banned substances e.g. drugs, alcohol, explosives
- Petrochemical exploration
- Environmental sensing
- Space applications
- Electrochemical solar cells
- Super capacitors
- Photonic devices

The technology has been tested as a device for biomarker detection and has specifically detected the concentration of a marker for inflammation at 55 picomoles.

## Commercialisation

Oxford University Innovation is seeking industrial interest from parties wishing to licence and commercialise this technology.

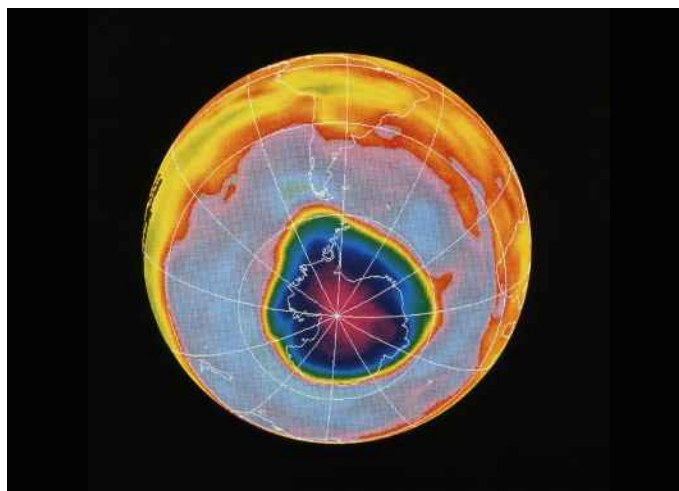

**For further information please contact:**  
**Bénédicte Menn**  
[benedicte.menn@innovation.ox.ac.uk](mailto:benedicte.menn@innovation.ox.ac.uk)  
**+44 (0)1865 280906**  
[www.innovation.ox.ac.uk](http://www.innovation.ox.ac.uk)  
**Project number: 13953**

## Technology Transfer from the University of Oxford

The information in this Project Profile is provided "as is" without conditions or warranties and Oxford University Innovation makes no representation and gives no warranty that it is the owner of the intellectual property rights in the technology described.

# Fast-response sensor for oxygen detection in gases and liquids



Researchers at the University of Oxford have produced a fast-response composite matrix that allows for the detection of oxygen in liquids and gases.

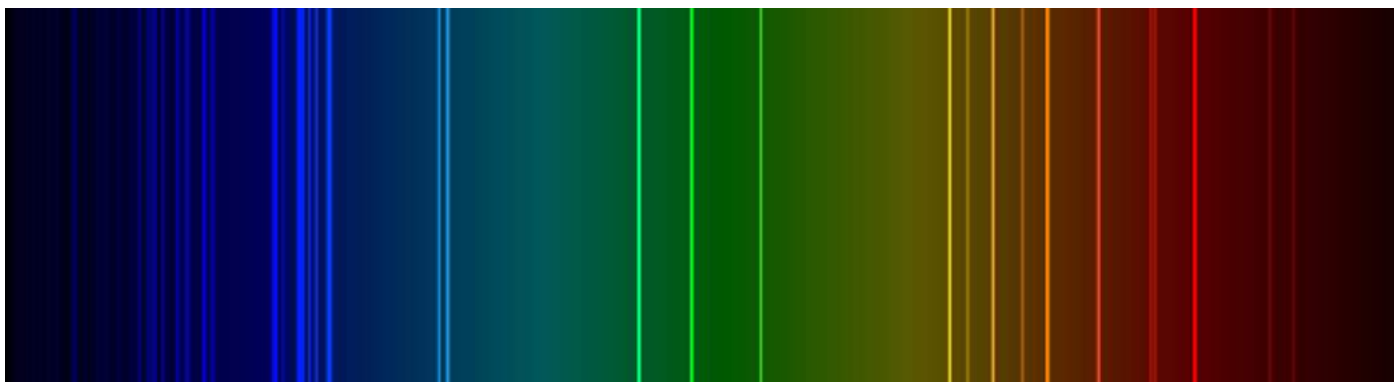

## The importance of measuring oxygen

Fast, accurate and reliable measurements of oxygen are very important in some medical applications, such as monitoring the rate of oxygen consumption of patients, or their oxygen partial pressure when they are under anaesthesia or suffering from acute lung conditions. Other applications include environmental or industrial process monitoring.

## Current state of the art

Current oxygen devices based on Winkler and colorimetric methods are either complex, time consuming, or do not have enough accuracy. Electrochemical methods, galvanic or polarographic (Clark-type), are dependent on the diffusion of oxygen, resulting in slow time-responses.

## A faster and more robust response

Researchers at the University of Oxford have developed an oxygen sensing matrix that permits the construction of fast-response optical devices for the detection of oxygen in liquid and gas phases.

Optical oxygen sensors depend on measuring the light emitted by a luminescent dye when interacts with oxygen. The oxygen sensing matrix developed by the University of Oxford is a composite of a biocompatible acrylate polymer, carbon nanomaterial and a commercial metalorganic dye.

The incorporation of carbon nanomaterials produces a very fast time response (less than 100 ms), even when the thickness of the sensing matrix is increased to improve its robustness. The biocompatibility of the polymer broadens the use of this matrix into medical applications.

Additional advantages of this new sensing matrix for this sensor are:

- Improved signal-to-noise ratio
- Sensitive and stable at low oxygen tensions – ideally suited to physiological range measurements
- Facile production
- Possibility of micro-sensor design

## Commercialisation

Oxford University Innovation has filed a patent application on this technology and would like to speak to potential partners interested in developing it for biomedical, or industrial applications.

**For further information please contact:**  
**Dr Dinali de Silva**  
[dinali.desilva@innovation.ox.ac.uk](mailto:dinali.desilva@innovation.ox.ac.uk)  
**+44 (0)1865 614441**  
[www.innovation.ox.ac.uk](http://www.innovation.ox.ac.uk)  
**Project number: 14110**

## Technology Transfer from the University of Oxford

The information in this Project Profile is provided "as is" without conditions or warranties and Oxford University Innovation makes no representation and gives no warranty that it is the owner of the intellectual property rights in the technology described.

# Magnetic microbubble-conjugated thrombin as a novel drug delivery system



Researchers at the University of Oxford have developed a novel drug delivery system to enable targeted delivery of thrombin to induce thrombosis in targeted anatomical locations.

A pseudoaneurysm, sometimes called a false aneurysm, occurs when a blood vessel wall is injured, and the blood is contained by the surrounding tissues. This can occur when blood escapes from the lumen of an artery through a defect in one or more layers of the arterial wall and forms a localised pocket of flow either beneath the outer wall of the artery or in the surrounding tissues.

Symptoms of a pseudoaneurysm could result in pain, swelling, bruising, and free extravasation of blood (rupture) into the surrounding tissue. Traditional methods of treatment include open surgical repair, or ultrasound guided compression of the pseudoaneurysm.

Surgical repair of the pseudoaneurysm requires general anaesthetic and can be complicated by infection of the wound and prolonged hospital stay for aftercare. Ultrasound guided mechanical compression is often avoided as the area affected is often swollen and tender.

For many years, direct injection of thrombin is used to treat pseudoaneurysms by causing thrombosis, which results in the formation of thrombus (clot). Ultrasound guided thrombin injection (UGTI) subsequently became a mainstream therapeutic option.

However, non-targeted delivery of thrombin can result in spill over of thrombin to non-affected area and cause thrombosis where it shouldn't.

Furthermore, when treating a pseudoaneurysm using conventional UGTI, it is difficult for the physician to know whether the treatment has been effective at the time of treatment.

Oxford researchers have developed a drug delivery system to enable targeted delivery of thrombin by applying a focused magnetic field to the area requiring treatment. This method aims to overcome many of the drawbacks of current methods used to treat pseudoaneurysms by delivering thrombin into a pseudoaneurysm much more accurately and thus reducing the risk of a further blood clot due to the thrombin being injected into the wrong place.

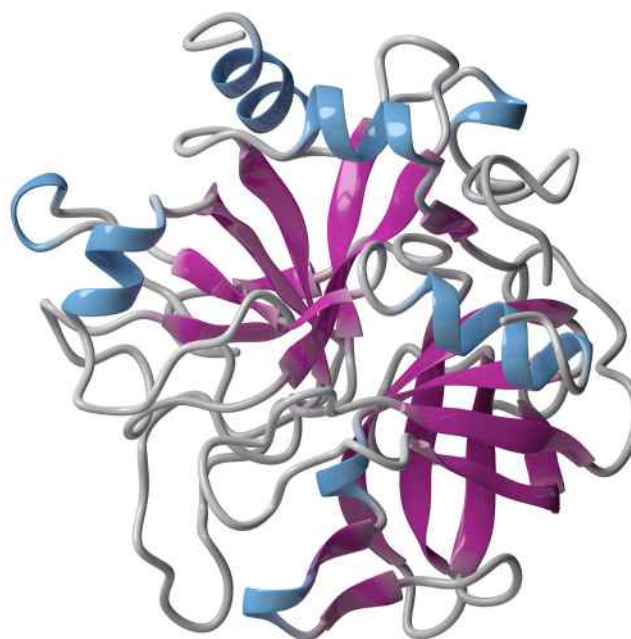

**For further information please contact:**  
**Dr Dinali de Silva**  
[dinali.desilva@innovation.ox.ac.uk](mailto:dinali.desilva@innovation.ox.ac.uk)  
**+44 (0)1865 614441**  
[www.innovation.ox.ac.uk](http://www.innovation.ox.ac.uk)  
**Project number: 14262**

## Technology Transfer from the University of Oxford

The information in this Project Profile is provided "as is" without conditions or warranties and Oxford University Innovation makes no representation and gives no warranty that it is the owner of the intellectual property rights in the technology described.



# Automated detection of bacterial growth from a photograph of a 96 well plate



Researchers at the University of Oxford have developed software to read digital images of microbial growth under different antibiotic conditions.

## Controlling antibiotic usage

Antibiotic resistance is one of the most pressing public health problems around the world. Resistance arises when bacteria change and continue to multiply in the presence of therapeutics levels of an antibiotic. Although resistance is a natural process, it develops more rapidly through the misuse and overuse of antibiotics. Therefore great care needs to be taken in selecting the correct antibiotics for treating each infection.

## High throughput screening

Microtitre plates are standard equipment in both clinical and research laboratories. They allow microbiologists to carry out large numbers of drug susceptibility testing on small amounts of material in a high throughput manner, thus giving clinicians rapid feedback on the most appropriate treatment for a given infection. Many laboratories use automated systems for filling and incubating the plates that can contain thousands of wells. However, analysis of the results of such studies is generally done by eye and is prone to mistakes. A more reliable way to measure the amount of bacterial growth would be of great benefit.

## Image processing of 96-well microtitre plate

Researchers at the University of Oxford have developed a software solution capable of interpreting the results of antibacterial assays carried out in 96-well plates. The technology makes use of existing camera infrastructure, but can significantly decrease the amount of human time required. Whilst this technology has been developed primarily for antibiotic susceptibility testing

using *M. tuberculosis*, it could also be used for *Bacillus subtilis*, *Staphylococcus aureus* and other circular forming bacterial colonies. This technology has been validated so far on more than 24,000 independent measurements of minimum inhibitory concentration (MIC).

The main benefits of the technology are:

- Rapid and accurate analysis of a photograph of 96-well plate assays
- Reduction of subjective nature of tests
- Low cost implementation
- Makes use of existing plate reader and image capture infrastructure
- Applicable to a research or clinical setting

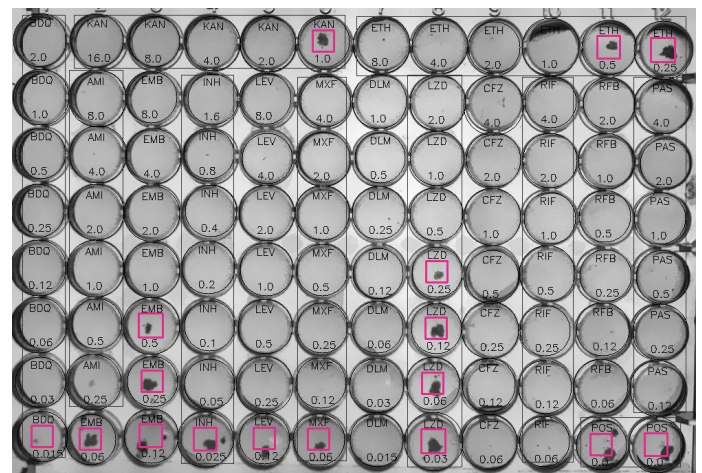

**For further information please contact:**  
**Bénédicte Menn**  
[benedicte.menn@innovation.ox.ac.uk](mailto:benedicte.menn@innovation.ox.ac.uk)  
**+44 (0)1865 280906**  
[www.innovation.ox.ac.uk](http://www.innovation.ox.ac.uk)  
**Project number: 14654**

## Technology Transfer from the University of Oxford

The information in this Project Profile is provided "as is" without conditions or warranties and Oxford University Innovation makes no representation and gives no warranty that it is the owner of the intellectual property rights in the technology described.

# Structural functionally graded blast panel for protection against traumatic brain injury



Researchers at the University of Oxford have developed a new design concept to protect individuals from blast explosions, in particular, to protect the wearer's brain from traumatic brain injury.

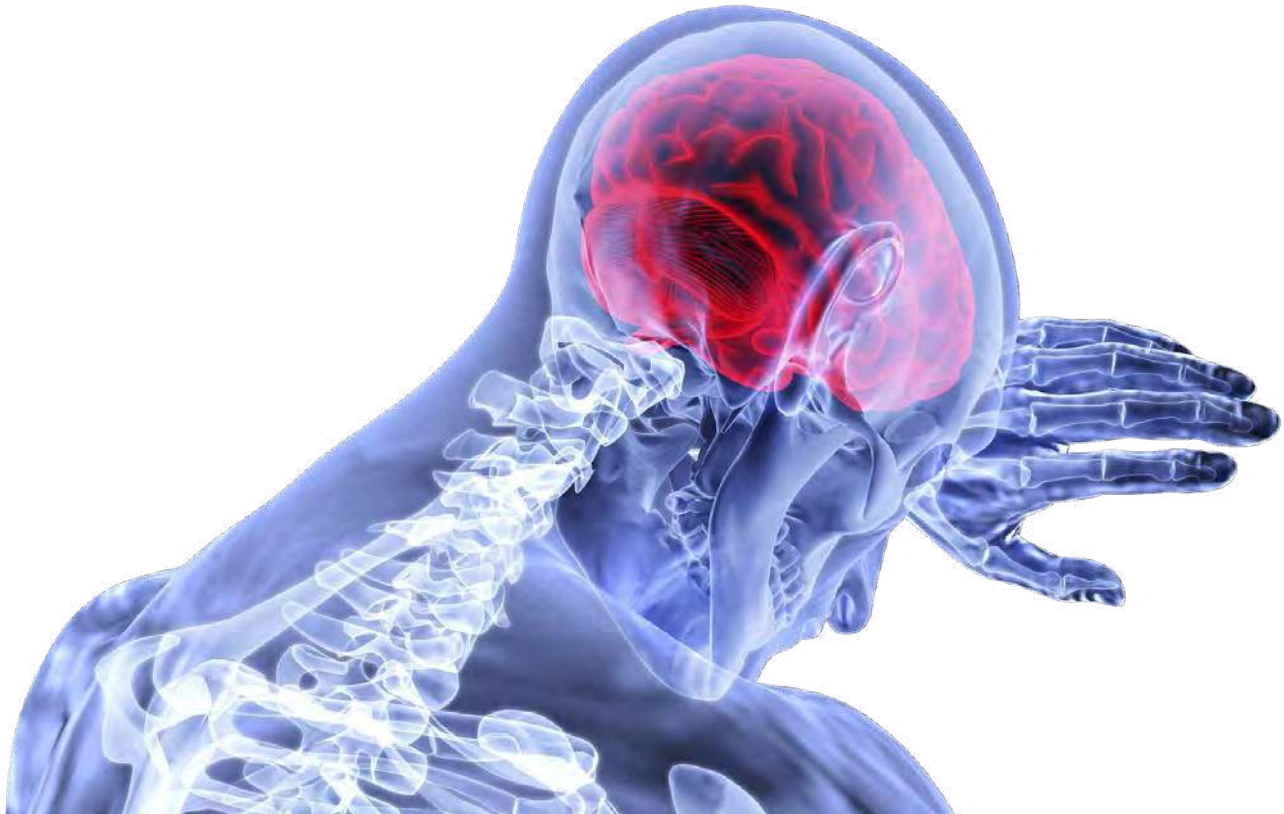

Blast-induced traumatic brain injuries as a result of explosions have been linked to a range of neurodegenerative and neuropsychiatric disorders.

Scientists at the University of Oxford have developed a new design concept for a structural material panel with varying mechanical properties, that when placed into a helmet or similar device, protects the user from shockwaves created by an explosion and thus from a traumatic brain injury.

Where conventional blast panels aim to reflect or attenuate the shockwave incident from explosions, the technology developed at Oxford works very differently by modifying the shape of the shockwave so as to avoid the concentration of stress to the centre of the skull.

The central region of the brain (around the ventricles) has been found to be particularly susceptible to damage from incident shockwaves.

The blast panel can be easily integrated into a device, which is more practical than conventional devices and by modifying the shape of the shockwave, has the potential to give the wearer better protection both from shockwaves and flying debris.

Blast front modifications have never been done in this manner and the technology has applications in any protective structure aimed at protecting the head against blasts as its primary function is to protect the wearer from incident shockwaves.

**For further information please contact:**  
**Dr Dinali de Silva**  
[dinali.desilva@innovation.ox.ac.uk](mailto:dinali.desilva@innovation.ox.ac.uk)  
**+44 (0)1865 614441**  
[www.innovation.ox.ac.uk](http://www.innovation.ox.ac.uk)  
**Project number: 14899**

## Technology Transfer from the University of Oxford

The information in this Project Profile is provided "as is" without conditions or warranties and Oxford University Innovation makes no representation and gives no warranty that it is the owner of the intellectual property rights in the technology described.

# Neuromorphic technology based on new physics



Oxford researchers have developed a signal processing platform that takes on the characteristics of a neuron without suffering from the power dissipation problems of conventional electronic circuits.

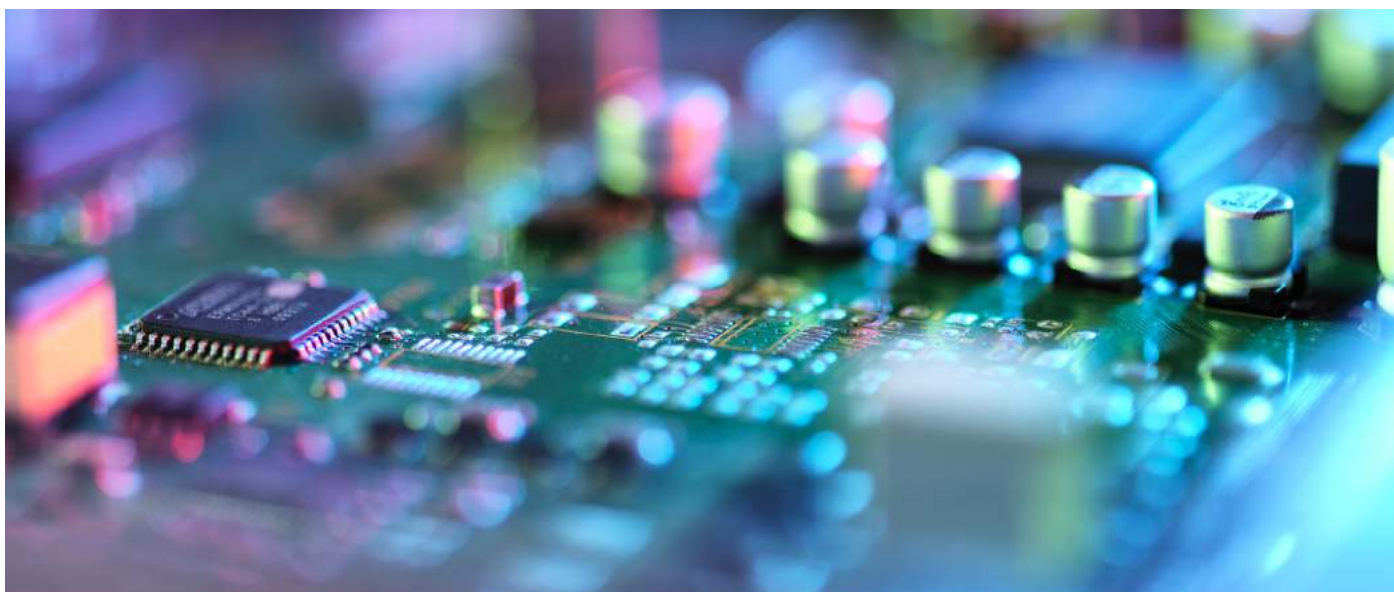

The semiconductor technology that fuelled the digital revolution has reached its limits. A further reduction in transistor size is being limited by quantum uncertainties, and next-generation supercomputers are struggling to withstand high temperatures that result from tremendous heat dissipation in these systems.

Apart from reaching their theoretical limits, non-biodegradable silicon-based technologies are not sustainable. Incremental solutions in the field are proving to be insufficient, demanding radical innovations. In dealing with these challenges, scientists have been taking inspiration from the extraordinary energy efficiency of the human brain, which has led to many innovations in computational hardware, known as neuromorphic computing.

Now inspired by the thermodynamics and material physics of neurons, a novel platform has been invented at the University of Oxford that closely mimics the computational properties and energy consumption of real neurons. The platform is based on the recently discovered phenomenon of nonlinear acoustic waves in liquid crystal thin films of lipids.

The nonlinear excitation and collision properties of these waves in a phase change material allow neuron-like computational capabilities in a substantially elastic and energy efficient system.

The salient features of the platform that set it apart from the competition are (a) mimics axonal computation including collisions, (b) computes in-material using analog non-linear spikes with efficiency close to real neurons, (c) operates at room temperature, and (d) uses biodegradable material.

The modular design of the signal processing unit will allow seamless integration for massively parallel computation and arbitrary network topology.

Finally, the neuron mimicking property of the platform can also be used for sensing or developing new assays for neuro-pharmaceutical and toxins.

**For further information please contact:**

**Dr Dinali de Silva**

**[dinali.desilva@innovation.ox.ac.uk](mailto:dinali.desilva@innovation.ox.ac.uk)**

**+44 (0)1865 614441**

**[www.innovation.ox.ac.uk](http://www.innovation.ox.ac.uk)**

**Project number: 15519**

## Technology Transfer from the University of Oxford

The information in this Project Profile is provided "as is" without conditions or warranties and Oxford University Innovation makes no representation and gives no warranty that it is the owner of the intellectual property rights in the technology described.

# Deep vein thrombosis diagnostic device



Researchers at the University of Oxford have developed a novel device for reliable point-of-care diagnosis of deep vein thrombosis.



## The deep vein thrombosis problem

Deep vein thrombosis (DVT) is a blood clot that forms within the deep veins of the limbs. If left untreated, half of these blood clots will travel to the lungs, forming a pulmonary embolism (PE). This is a leading cause of death, greater than AIDS, breast cancer, prostate cancer and car crashes combined. Each year, DVT affects around 1 person in every 1,000 in the UK and the total cost burden to the UK of management of DVT and PE is estimated at approximately £640 million. Globally, the clot management devices market was valued at \$1.26 billion in 2015 and is further expected to reach a value of \$1.88 billion by 2024.

Ultrasound is the standard method for diagnosis of DVT. However, an ultrasound procedure has to be performed by a trained radiologist and requires a referral to the hospital. Currently, only 15% of hospital referrals have confirmed DVT. Unnecessary referrals for patients with suspected DVT cost the NHS more than £100M per year. There is an added problem with hospital referrals as it often requires the GP to prescribe preventative

anticoagulants, posing a further unnecessary health risk. A 2016 survey of over 1000 UK GPs indicated that a more accurate DVT diagnosis is the top need to reduce referrals.

## A point-of-care solution

Researchers at the University of Oxford have developed an easy-to-use point-of-care solution that can improve screening of DVT patients in primary care, avoiding the need for unnecessary referrals and treatments.

Oxford University Innovation is seeking partners to license this innovative technology and support its continued development. A patent application has been filed to cover this method.

**For further information please contact:**

**Dr Philippa Christoforou**

**[philippa.christoforou@innovation.ox.ac.uk](mailto:philippa.christoforou@innovation.ox.ac.uk)**

**+44 (0)1865 280842**

**[www.innovation.ox.ac.uk](http://www.innovation.ox.ac.uk)**

**Project number: 15595**

## Technology Transfer from the University of Oxford

The information in this Project Profile is provided "as is" without conditions or warranties and Oxford University Innovation makes no representation and gives no warranty that it is the owner of the intellectual property rights in the technology described.

# A new treatment to predict the growth in abdominal aortic aneurysms



Scientists at the University of Oxford have used the pulsation characteristics of an artery for the prediction of growth of abdominal aortic aneurysms in humans.

## What is abdominal aortic aneurysm?

The aorta is the main blood vessel that carries blood from the heart to the rest of the body. An abnormal expansion in the abdominal region of the aorta is called an abdominal aortic aneurysm (AAA). When an AAA continues to expand, there is an increased risk of it bursting and this can lead to internal bleeding and in many cases, death. Ruptured AAAs kill approximately 200,000 people in the world each year, and of these 6000 are in the UK.

To prevent AAA ruptures, AAA screening programs have been implemented in the UK, Sweden, Australia, and Germany – with other countries to follow. In the NHS alone, more than 100,000 ultrasound scans are performed each year for AAA surveillance. However, many of these scans are redundant if we are able to predict the growth of the AAA.

AAA's can be treated by surgery but usually this only occurs when an aneurysm reaches a certain size (>5.5cm). It has been shown that aneurysm size alone may not be an absolute predictor of the risk of rupture. Furthermore, the rate of AAA progression may vary significantly between individuals and the growth rate of an AAA is a good indicator as to whether surgical intervention is required.

## Overcoming challenges

In a recent international survey of vascular surgeons, developing novel methods for the prediction of AAA growth was voted as the top priority for research in AAA. There is, therefore, a requirement for a non-invasive method for the prediction of aneurysm growth and we have found that using the pulsation characteristics of an artery to be such a method.

Scientists at the University of Oxford have devised a method for predicting the rate of growth of abdominal aortic aneurysms in humans using the pulsation characteristics of an artery during ultrasound imaging, such as the brachial artery of the arm.

## Commercialisation

Oxford University Innovation has filed a priority patent application on the technology and welcomes discussions with companies interested in licensing it for commercial development .



**For further information please contact:**

**Dr Dinali de Silva**

**dinali.desilva@innovation.ox.ac.uk**

**+44 (0)1865 614441**

**www.innovation.ox.ac.uk**

**Project number: 15648**

## Technology Transfer from the University of Oxford

The information in this Project Profile is provided "as is" without conditions or warranties and Oxford University Innovation makes no representation and gives no warranty that it is the owner of the intellectual property rights in the technology described.

# A novel algorithm for biologically inspired lighting solutions



Oxford researchers have developed a method to generate metamers with non-linear light sources to selectively stimulate melanopsin in the human eye, thereby potentially affecting the circadian rhythms and alertness without a change in appearance.

## Biologically inspired lighting

Light emitting diodes (LEDs) are widely used for various lighting applications, including display backlighting, automotive lighting and mobile applications. The global LED lighting market is expected to increase at a high growth rate and will reach \$80 billion by 2020. In particular, human-centric or biologically relevant lighting, which requires precise control of intensity, colour and level, will dominate the lighting space.

Melanopsin is involved in the regulation of the sleep-wake cycle, circadian rhythms, and many other fundamental physiological aspects. Using multiple LEDs, it is possible to create lights that differ in the amount that they stimulate melanopsin but do not differ in their appearance. These are called metamers and demonstrate how non-visual properties of light can be modulated independently of visual appearance.

## The problem with non-linearity of real light sources

Metamers for a light source with multiple LEDs can be accurately characterised to activate a desired photoreceptor given any set of input intensity values for each LED. However, where light sources are non-linear and exhibit spectral shifts as a function of input intensity, it is non-trivial to construct metamers and inaccuracies will necessarily result, leading to problems such as undesired colour distortions.

## Novel methods to generate metamers using an algorithm

Researchers at the University of Oxford have developed a novel method to generate metamers with non-linear light sources using an algorithm which incorporates spectral shifts in real light sources. Using a predicted output spectrum, the melanopsin signal and cone signal, for example, can be optimised such that specific spectral properties are achieved. This may include no difference in cone signal between two spectra, and maximal difference in melanopsin.

The method can be used to make biologically inspired spectra to maximally or minimally stimulate melanopsin, thereby modulating the alertness of an individual, or cause differences in circadian or sleep-related outputs, such as melatonin suppression. Other applications include optimising for a specific Colour Rendering Index (CRI), or other colour rendition metrics.

The main advantages of this method are:

- Precise light control with multiple non-linear light sources, such as LEDs
- Generation of calibrated light spectra from a low number of calibration measurements
- Useful for all settings in which the spectrum of a multi-primary light source needs to be controlled, such as biologically inspired solutions or light therapy

A patent application has been filed on this technology. Oxford University Innovation is interested in talking to potential partners for the commercialisation of this new method.



**For further information please contact:**  
**Dr Philippa Christoforou**  
[philippa.christoforou@innovation.ox.ac.uk](mailto:philippa.christoforou@innovation.ox.ac.uk)  
**+44 (0)1865 280842**  
[www.innovation.ox.ac.uk](http://www.innovation.ox.ac.uk)  
**Project number: 15823**

## Technology Transfer from the University of Oxford

The information in this Project Profile is provided "as is" without conditions or warranties and Oxford University Innovation makes no representation and gives no warranty that it is the owner of the intellectual property rights in the technology described.

# Multifunctional device for focusing light through an optical component



Oxford researchers have developed a multifunctional lens which is capable of imaging phase modulation and polarisation modulation simultaneously.

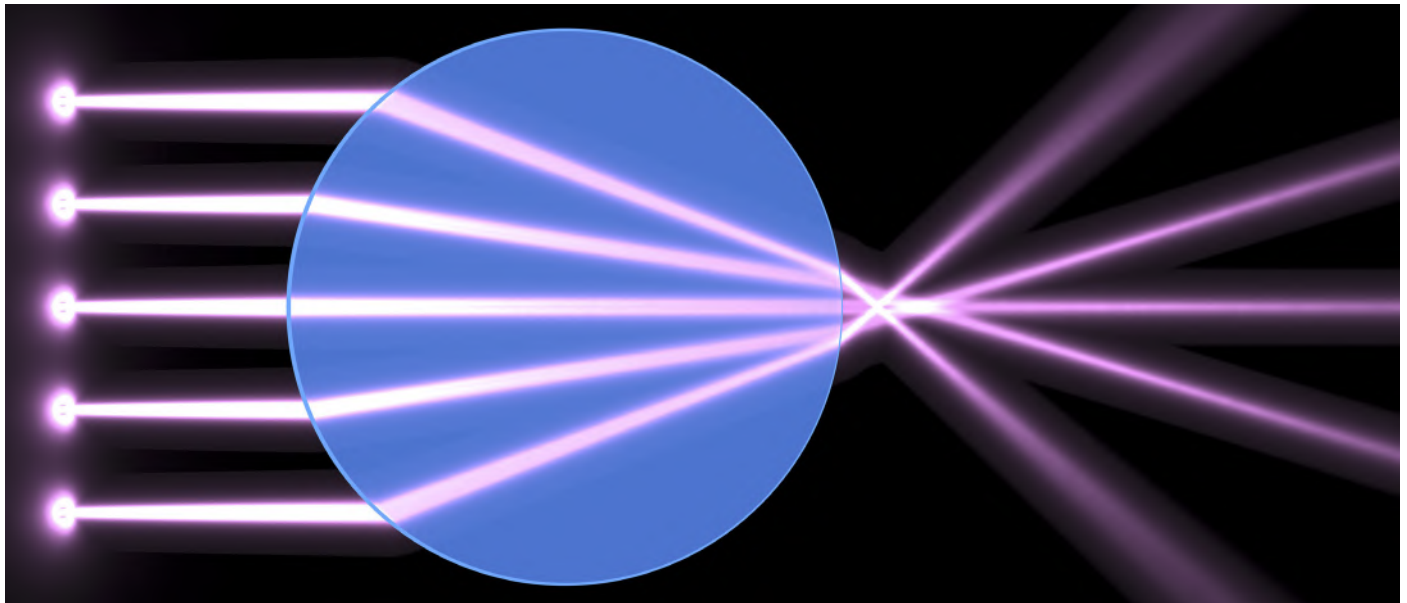

## Harnessing birefringence properties in multifunctional GRIN lens based cascades

Graded Index (GRIN) lenses are affordable, flat, rigid lenses commonly used for compact imaging systems. GRIN lenses have the inherent property of radially changing birefringence, a property undesired for most applications.

Researchers at the University of Oxford have drawn previously undesirable birefringence properties of GRIN lenses to build GRIN lens cascades. GRIN lens cascades are light manipulation structures that enable novel extra functionality in commonplace GRIN lens systems, extending their range of applications.

GRIN lenses are sold widely today. Their low mass and size means optical devices using GRIN-lenses can be created in an easier, more stable, compact, low-cost way compared with conventional methods, such as using adaptive spatial light modulators or q-plates.

The GRIN based lens cascade could be applied as a multi-functional optical device which is capable of imaging, phase modulation and polarisation modulation simultaneously.

The main applications include:

- A new vector vortex beam (VVB) generator that could benefit complex light beam engineering as well

as modification of the shape of laser beam focus for microscopy and super-resolution applications

- A new orbital angular momentum (OAM) generator that could benefit further microscope techniques including optical tweezing, sensing in astronomy, as well as quantum optics communication
- A new single-shot Mueller matrix measurement probe that could assist minimally invasive surgery techniques to do simultaneous scanning for detecting the boundary of, say a cancerous tumor, as a label-free indicator

## Patent protection

A patent has been filed which covers this technology. Oxford University Innovation is interesting in talking to potential partners to aid in the commercialisation of these new methods.

**For further information please contact:**

**Adrian Coles**

[adrian.coles@innovation.ox.ac.uk](mailto:adrian.coles@innovation.ox.ac.uk)

+44 (0)1865 614432

[www.innovation.ox.ac.uk](http://www.innovation.ox.ac.uk)

Project number: 16143, 16372

## Technology Transfer from the University of Oxford

The information in this Project Profile is provided "as is" without conditions or warranties and Oxford University Innovation makes no representation and gives no warranty that it is the owner of the intellectual property rights in the technology described.

# Soil-structure interaction sensor



Oxford researchers have developed an innovative and simple sensor capable of measuring all parameters needed to fully quantify a soil-structure interface.

## The problem

Underground structures are often a key component in large-scale construction projects, including tunnels, shafts, foundations and deep excavations. These structures are exposed to contact with the surrounding soil, which is typically critical to their operation.

The normal and frictional contact stresses associated with this interaction can be monitored by installing sensors within the soil-structure interface. Existing sensors are not well suited to the harsh environments of construction monitoring, suffering from electromagnetic interference and damage through water ingress. They are also typically expensive, difficult to fabricate and unable to provide a complete assessment of interface stresses, relying on additional instrumentation to measure pore water pressure.

## The solution

To surmount the limitations of existing systems, engineers at the University of Oxford have developed an innovative and simple sensor capable of measuring all parameters needed to fully quantify a soil-structure interface. This includes the normal stress and bi-directional shear stresses (and their eccentricities), alongside pore water pressure and temperature. The device comprises a simple square structure that employs a novel mechanism of deformation to allow for measurement of pore water pressure. A machine learning approach is used with the strain sensitive transducers on the sensor structure to distinguish the complex deformations induced under the different loads. This allows a significantly lower number of strain transducers to be used, reducing sensor complexity and overall cost.

## Advantages of this device include:

- More cost effective than existing sensor technologies
- Capable of measuring all stresses associated with a soil-structure interface
- Avoids the need for installation of additional instrumentation
- No damage through water ingress or electromagnetic interference
- Simplified design and straightforward manufacture compared to existing technologies

## Commercialisation

Oxford University Innovation is currently seeking a licensee to help commercialise this technology. A patent protecting the invention is currently pending.



**For further information please contact:**  
**Sandeep Singh**  
[sandeep.singh@innovation.ox.ac.uk](mailto:sandeep.singh@innovation.ox.ac.uk)  
**+44 (0)1865 280907**  
[www.innovation.ox.ac.uk](http://www.innovation.ox.ac.uk)  
**Project number: 16735**

## Technology Transfer from the University of Oxford

The information in this Project Profile is provided "as is" without conditions or warranties and Oxford University Innovation makes no representation and gives no warranty that it is the owner of the intellectual property rights in the technology described.



# Rapid method for the measurement of foetal scalp blood pH



Researchers at the University of Oxford have developed a bespoke analytical method suitable for use *in-vivo* for the measurement of human foetal scalp blood pH that will transform pregnancy management and delivery outcomes.

In the US and EU, 9 million babies are born each year. 50% of the babies born will be subject to continuous electronic foetal heart monitoring and have the potential to require foetal scalp blood pH monitoring.. Failure to assess foetal status by performing foetal scalp blood pH or a delay in obtaining foetal scalp blood pH is a major case of litigation. In the last NHS litigation report, maternity accounted for over half the litigation budget, £700m out of a total budget of £1.68m.

An abnormal pH measured in foetal scalp blood is indicative of foetal distress. Foetal distress is any condition in which a fetus is endangered, struggling or unwell, which is typically characterised by the fetus not having an adequate oxygen supply. If foetal distress is not corrected in a timely manner, this can cause irreversible harm to the fetus, such as neo-natal brain damage. Blood pH measurements can therefore be used to determine whether any medical intervention, such as a Caesarean section, is required.

Foetal scalp blood pH measurements currently used suffer from a large number of false negatives and measurement failures often resulting in unnecessary and potentially harmful medical intervention, such as Caesarian section. Caesarean sections involve much greater risks compared to natural birth, such as an increased risk of surgical injury to both the mother and child. Even without major complications, caesarean section typically involves more blood loss, an increased risk of infection, and an increased risk of uterine rupture in further pregnancies.

As the process of obtaining foetal scalp pH is technically difficult, it is something that many clinicians avoid. Making the process significantly easier will encourage its use.

Scientists at Oxford have developed a method of reliably and accurately measuring foetal blood pH and giving a measure of the quality of the result. The method, with partners, is suitable for translation into a practical sensor with many advantages over the current technologies. The quality of pH measurement is a novel and generic feature. This bespoke sensor would make the process of obtaining foetal scalp blood easier, be able to be performed at smaller cervical dilation, by midwives or doctors and give a much faster result. This would, in turn, lead to increased use of pH measurement and reduced adverse perinatal outcomes by allowing more timely delivery of at risk babies.



Image: Human foetus at 12 weeks, ultrasound scan.

**For further information please contact:**

**Dr Dinali de Silva**

**dinali.desilva@innovation.ox.ac.uk**

**+44 (0)1865 614441**

**www.innovation.ox.ac.uk**

**Project number: 16569**

## Technology Transfer from the University of Oxford

The information in this Project Profile is provided "as is" without conditions or warranties and Oxford University Innovation makes no representation and gives no warranty that it is the owner of the intellectual property rights in the technology described.



GENOMICS

Databases for hosting nomenclatures linked to whole genome sequences for molecular characterisation of bacteria.



## Sequencing the bacterial genome

Researchers at the University of Oxford have developed databases for hosting nomenclatures linked to whole genome sequences for molecular characterisation of bacteria.

The PubMLST website (<https://pubmlst.org/>) hosts curated molecular typing data for over a hundred microorganisms, providing sequence and allelic profile definitions for multi-locus sequence typing (MLST) and single-gene methods. In recent years, these have expanded to cover the whole genome with schemes such as core genome MLST (cgMLST) cataloguing the allelic diversity found in hundreds to thousands of genes. These methods provide a common nomenclature for high resolution strain identification and comparison.

The underlying genomics platform, BIGSdb, links molecular typing information to isolate provenance, phenotype, and increasingly genome assemblies, providing a rich resource for outbreak investigation and research in to population structure, gene association, global epidemiology and vaccine coverage.

## Scaling up with population genomics

Databases include those for *Neisseria* spp., *Campylobacter* spp., *Staphylococcus aureus* and *Streptococcus pneumoniae*, which between them contain over 61,000 genomes, linked to typing nomenclatures, structured catalogues of gene variants and provenance information.

Data are made available on an open access basis through the PubMLST website and its application programming interface. For private, commercial use Oxford University Innovation offers mirror-site licences to selective databases or on a fully-flexible basis. This facilitates local linking and integration of private data to the large amount of available genome data and authoritative nomenclature schemes.

**For further information please contact:**  
**Dr Matt Carpenter**  
[matthew.carpenter@innovation.ox.ac.uk](mailto:matthew.carpenter@innovation.ox.ac.uk)  
**+44 (0)1865 280970**  
[www.innovation.ox.ac.uk](http://www.innovation.ox.ac.uk)  
**Project number: 10531, 15179**

## Technology Transfer from the University of Oxford

The information in this Project Profile is provided "as is" without conditions or warranties and Oxford University Innovation makes no representation and gives no warranty that it is the owner of the intellectual property rights in the technology described.

# Chromopainter – Identifying shared ancestry



**Available to license:** An algorithm that analyses data from dense genotyping chips to infer local ancestry with high precision

Oxford researchers have developed an algorithm which can precisely identify stretches of DNA that are shared among individuals

## Ancestral analysis

Tracing the genetic origin of a species can provide unprecedented insight into the history of a population. By comparing the DNA of individuals, genetic analyses can unearth information about the geographical and temporal ancestral relatives of an individual or group. This technology has wide ranging applications from disease mapping to understanding human history.

## Analysis methods

Accurately identifying segments of DNA that individuals have inherited from different ancestral sources can be highly challenging.

Previous methods have used data that is too coarse, leading to ambiguous predictions, or they have failed to account for linkage disequilibrium, the connection between several allele at different loci, potentially resulting in misleading or incomplete inferences.

## Chromopainter – Ancestry evolved

Oxford researchers have developed Chromopainter, an algorithm that analyses data from dense genotyping chips to infer local ancestry with very high precision. It is the most accurate tool of its kind as it makes use of key haplotypes, groups of genes that are inherited concurrently. These haplotype markers are known to be more informative than the simple use of individual loci. Simulations have demonstrated the ability of Chromopainter to uncover previously unknown aspects of population history.

The key benefits of the Chromopainter method are as follows:

- Analyses dense, large-scale diploid data from individuals with mixed ancestry
- More powerful than existing approaches at inferring ancestry
- Increased precision to distinguish between closely related ancestral sources
- Utilises haplotype information that many previous approaches ignore

The software is copyright protected and Oxford University Innovation Ltd wish to talk to companies who may be interested in using the Chromopainter algorithm.



**For further information please contact:**  
**Dr Richard Auburn**  
[richard.auburn@innovation.ox.ac.uk](mailto:richard.auburn@innovation.ox.ac.uk)  
**+44 (0)1865 280956**  
[www.innovation.ox.ac.uk](http://www.innovation.ox.ac.uk)  
**Project number: 14061**

## Technology Transfer from the University of Oxford

The information in this Project Profile is provided "as is" without conditions or warranties and Oxford University Innovation makes no representation and gives no warranty that it is the owner of the intellectual property rights in the technology described.

## **Available to license:** Fast, memory efficient genotype imputation software

Oxford researchers have developed a software package for statistical analysis of genome-wide data using novel algorithms

### **Genome-Wide Association (GWA)**

GWA studies involve analysing a genome-wide set of genetic variants to probe the relationship between variants and phenotypes. In general, the variants examined are Single Nucleotide Polymorphisms (SNPs) and the traits are major human diseases. GWA has proven to be a powerful tool in identifying the complex genetic linkages that underpin some of the most common, yet complex, human diseases and represents a significant improvement over previous methods.

### **Imputing variants**

At present, GWA studies using commercially available genotyping chips assay a huge number (> 100,000) of markers across the genome, but this represents a small percentage of the overall number of known SNPs. It is therefore unlikely that the true causal variant would be included on the chip. Geneticists have proposed that in order to increase the amount of information gained from a GWA study, and to account for these unidentified variants, the data obtained must be subject to imputation to identify the untyped disease variants.

### **Evolutionary genetics analysis software**

IMPUTE 4 is a software program for imputation/estimation of unobserved and missing SNP alleles in a dataset, consisting of genotype data on a set of individuals based upon a panel of known haplotype data and a recombination map.

The idea of imputing alleles is very popular in genetics studies of human disease and is being used to enable researchers to find new disease genes and share data.

The software allows more precise and efficient prediction than other algorithms available.

The main benefits of IMPUTE 4 include:

- Best-in-class performance
- Accounts for combinations of different SNP sets (including HapMap)
- Can be used to validate and correct data at genotyped markers
- Fast and flexible modelling strategy – accurate at common and rare SNPs

### **Oxford Genome-Wide Analysis Software Suite (OGWASS)**

IMPUTE 4 is part of the Oxford Genome-Wide Analysis Software Suite (OGWASS) for statistical analysis of genetic information. Oxford University Innovation is seeking licensees who may wish to obtain a commercial licence to IMPUTE 4 or indeed the entire OGWASS family.



**For further information please contact:**

**Dr Richard Auburn**

[richard.auburn@innovation.ox.ac.uk](mailto:richard.auburn@innovation.ox.ac.uk)

**+44 (0)1865 280956**

[www.innovation.ox.ac.uk](http://www.innovation.ox.ac.uk)

**Project number: 14128**

## **Technology Transfer from the University of Oxford**

The information in this Project Profile is provided "as is" without conditions or warranties and Oxford University Innovation makes no representation and gives no warranty that it is the owner of the intellectual property rights in the technology described.

# DNA cloning without sequence constraints and without 'scar' sequences



Academics from the University of Oxford have developed a method for sequence-independent DNA cloning of DNA fragments that can be over 250kb.



DNA assembly/cloning is the cornerstone of synthetic biology and is the process of physically linking together multiple smaller DNA fragments into a large fragment.

Our technology will therefore support customers in sectors as diverse as pharmaceuticals, industrial biotechnology and agricultural sectors, as well as any emerging synthetic biology company. Each of these customers has a shared requirement for rapid, simple and error-free DNA assembly.

Potential routes to commercialisation for this technology include offering custom DNA synthesis services, partnerships with existing market leaders, retailing kits for non-expert internal use and developing bespoke synthetic biology products. The foundation IP comprises a method for sequence-independent DNA cloning of DNA fragments that can be over 250kb. This IP is protected by two patent applications, plus software that facilitates the assembly process.

## Limitations of traditional systems

Traditional DNA cloning systems using type IIS restriction enzymes require two or more enzymes for hierarchical assembly of large DNA constructs. This process is particularly complex and expensive and because the DNA fragment to be cloned need to be free of the restriction sites for the enzymes used, not all DNA sequences can be assembled. The incumbent systems also leave unwanted 'scar' sequences within the assembled DNA.

There is a widespread need for an approach that addresses these limitations and improves the ability to assemble larger sequences of DNA.

## Advantages of the Oxford method include:

- Any DNA sequence can be cloned without the need to remove restriction sites
- Can clone fragments over 250kb
- Simple one-pot cloning reaction using a circular DNA plasmid as input
- The use of a single restriction enzyme throughout all cloning stages
- Option of hierarchical scarless cloning of any DNA sequence using a fixed set of assembly vectors
- Simple efficient replacement method for traditional cloning

## Available for license

Oxford University Innovation would like to hear from interested parties who may wish to commercialise this technology.

### For further information please contact:

**Dr Richard Auburn**

[richard.auburn@innovation.ox.ac.uk](mailto:richard.auburn@innovation.ox.ac.uk)

+44 (0)1865 280956

[www.innovation.ox.ac.uk](http://www.innovation.ox.ac.uk)

Project number: 14253, 15614, 15792

## Technology Transfer from the University of Oxford

The information in this Project Profile is provided "as is" without conditions or warranties and Oxford University Innovation makes no representation and gives no warranty that it is the owner of the intellectual property rights in the technology described.

# Gap-Seq: single molecule sequencing for single-molecule phenotyping



Researchers at the University of Oxford have developed a single-molecule sequencing method capable of connecting the functionality (reactions or interactions) of a single nucleic acid molecule with its sequence.



DNA sequencing is a key method that has had a huge impact on diagnostics, genomics and functional analysis. Although many single-molecule sequencing methods exist, there is currently no proficient way to connect the functional properties of a single DNA molecule with its sequence.

## Single-molecule sequencing

Within the last decade, single-molecule sequencing has been utilised in the commercial long-read sequencing market. However, the methods currently used by these companies require specialist equipment and cannot directly link single-molecule phenotype with a DNA sequence. Providing such a link between a single molecule phenotype and its structure would support screening for biomolecules.

There is, therefore, a need for an alternative method that can fulfil this need whilst making use of standard laboratory equipment.

## Gap-Seq- a novel sequencing solution

Researchers at the University of Oxford have developed a single-molecule method, called Gap-Seq, that connects

the functionality (e.g., chemical reactions and molecular interactions) of large libraries of single nucleic acid molecules (or tagged peptides) with their sequence. This method allows biomolecules of interest (such as aptamers and DNA-binding sites) to be screened rapidly and quantitatively for functionality against specific molecular targets using standard laboratory equipment.

## Commercialisation

Oxford University Innovation has applied for a patent for this technology and would like to hear from any interested parties who may wish to commercialise this technology.

**For further information please contact:**  
**Dr Richard Auburn**  
[richard.auburn@innovation.ox.ac.uk](mailto:richard.auburn@innovation.ox.ac.uk)  
**+44 (0)1865 280956**  
[www.innovation.ox.ac.uk](http://www.innovation.ox.ac.uk)  
**Project number: 14526**

## Technology Transfer from the University of Oxford

The information in this Project Profile is provided "as is" without conditions or warranties and Oxford University Innovation makes no representation and gives no warranty that it is the owner of the intellectual property rights in the technology described.

# Sparse decomposition of arrays (SDA)



Oxford researchers have developed software that decomposes 3D arrays (or tensor) of gene expression measurements to identify gene networks that are associated with genetic variation.



Genetic variability across individuals is responsible, to a certain extent, for the differences in physiological traits of an individual, including their susceptibility to diseases and response to drug treatments.

Due to its clinical relevance, studies focused on discovering components of genome that contribute to genetic variation have been widely conducted.

## Gene expression traits

Expression quantitative trait loci (eQTLs) are loci that partly give rise to the variation in gene expression. eQTLs can operate proximally (cis-) or distantly (trans-) on a gene. So far, cis-eQTLs are easier to identify than trans-eQTLs. This is due to potential regulatory effects from the entire genome - as opposed to in the vicinity of a gene - is statistically and computationally difficult.

Oxford researchers have developed software that decomposes the tensor of gene expression datasets across multiple tissues and individuals in order to identify trans-eQTLs and gene networks that can lead to genetic variation based on a Bayesian method. The software confers the following advantages:

- Based on a novel and efficient algorithm

- Uses a flexible sparse assumption that can help uncover true, sparse underlying effects
- Complements current eQTL analysis pipelines that focus mainly on identifying cis-eQTLs in a single tissue
- Shown to work on real datasets (RNA sequencing data from 854 individuals from the TwinsUK cohort)

The work was published in *Nature Genetics* and the software is available online for academic usage.

## Commercialisation

Oxford University Innovation is interested in hearing from organisations that would like to license this software commercially to support their research and development.

**For further information please contact:**

**Dr Richard Auburn**

[richard.auburn@innovation.ox.ac.uk](mailto:richard.auburn@innovation.ox.ac.uk)

+44 (0)1865 280956

[www.innovation.ox.ac.uk](http://www.innovation.ox.ac.uk)

Project number: 14872

## Technology Transfer from the University of Oxford

The information in this Project Profile is provided "as is" without conditions or warranties and Oxford University Innovation makes no representation and gives no warranty that it is the owner of the intellectual property rights in the technology described.



# RELATE: estimating genome wide genealogies for thousands of whole-genome sequences



Researchers have developed software that enables genome-wide genealogies in the form of trees that adapt to changes in local ancestry caused by recombination.

RELATE is new software from the University of Oxford that enables estimation of genome-wide genealogies. RELATE makes inference of genealogical histories for large sample sizes possible, previously unachievable for all but the smallest datasets. RELATE-estimated genealogies will allow for more comprehensive downstream analyses to be produced.

## Genome-wide genealogies for thousands of samples

Genealogies describe how DNA samples are related through most recent common ancestors back in time. In principle, they are the best attainable record of the genetic past of a sample of DNA sequences and therefore, if known, simplify and substantially enhance any inferences we make about our shared genetic past.

RELATE makes inference of genealogical histories for large sample sizes possible, a problem that despite its importance had previously remained infeasible for all but the smallest datasets. RELATE scales to >10,000 sequences and improves on accuracy in scenarios with realistic levels of errors.

## Tools for downstream analyses

RELATE comes with tools for downstream analyses of inferred genealogies to tackle a broad range of applications, including for estimating demographic history, mutation rates, and detection of positively selected mutations. Genealogy-based inferences can be more powerful or more accurate than alternative specialist methods.

## Main benefits include:

- Scalable to thousands of whole-genome sequences

- Very powerful inference framework applicable to questions related to evolutionary biology, population genetics, and genetic disease.
- All inferences are derived from the same genealogies leading to better consistency across different applications
- Improved accuracy in areas of realistic errors

## Commercialisation

Oxford University Innovation is actively seeking partners that may wish to licence this software. For further details, please see the research groups webpage <https://myersgroup.github.io/relate/>



**For further information please contact:**  
**Dr Richard Auburn**  
[richard.auburn@innovation.ox.ac.uk](mailto:richard.auburn@innovation.ox.ac.uk)  
**+44 (0)1865 280956**  
[www.innovation.ox.ac.uk](http://www.innovation.ox.ac.uk)  
**Project number: 15670**

## Technology Transfer from the University of Oxford

The information in this Project Profile is provided "as is" without conditions or warranties and Oxford University Innovation makes no representation and gives no warranty that it is the owner of the intellectual property rights in the technology described.

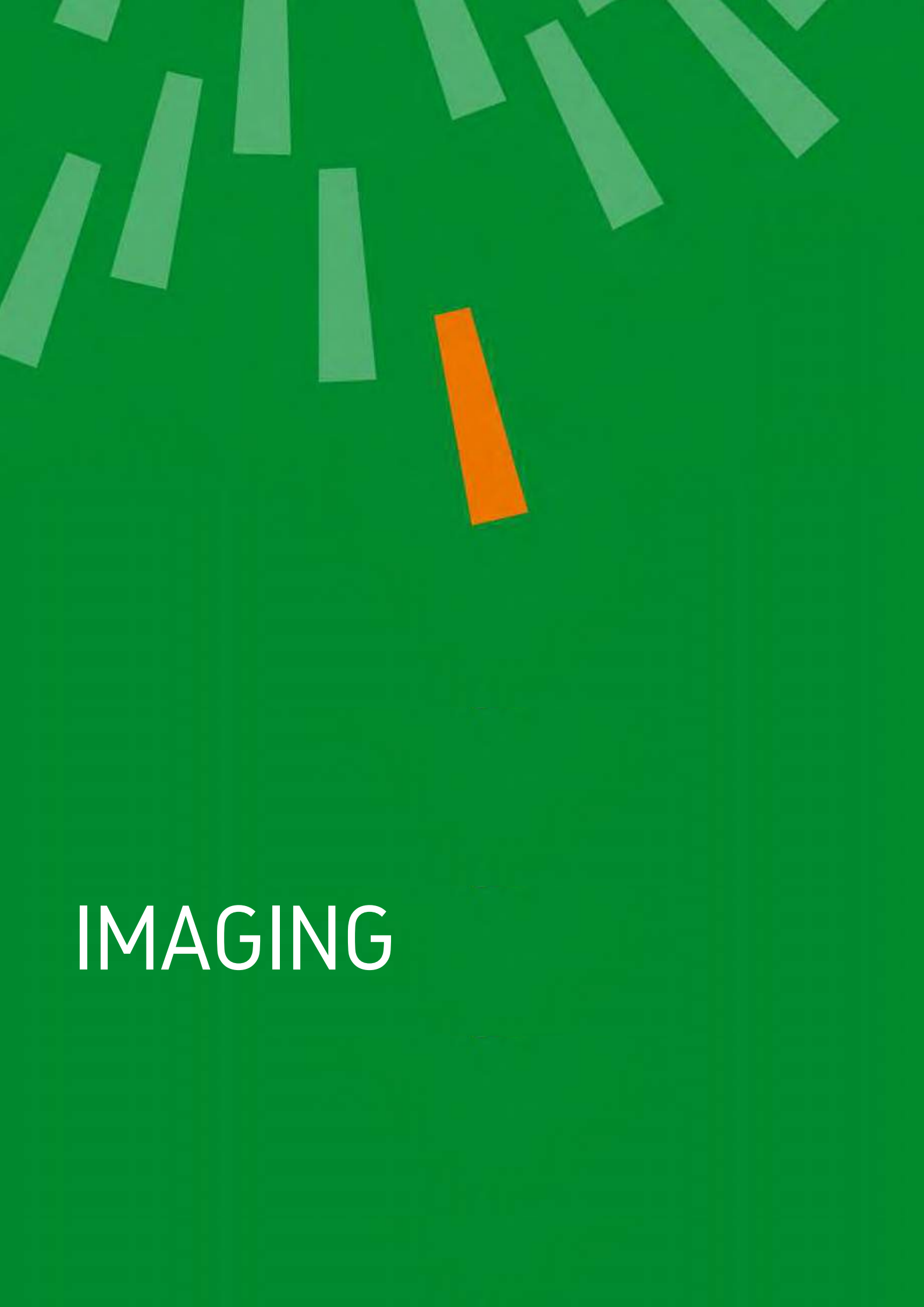

IMAGING

# Targeted MRI contrast agents for detection of brain tumours and inflammation



Oxford University researchers have developed a new generation of targeted MRI contrast agents that enable detection of specific disease-related molecules on blood vessels *in vivo*.

## The next generation

Oxford University researchers have developed a new generation of targeted MRI contrast agents that enable detection of specific disease-related molecules on blood vessels *in vivo*. These multimeric, biodegradable, imaging agents for MRI can be coupled with targeting agents to find, amongst other things, lesions in the blood brain barrier. The imaging agents are comprised of novel sugar coated iron oxide particles and can be used to identify endothelial cell activation in the brain. They are sufficiently sensitive to detect tumours in less than 10 minutes of imaging and has potent MRI contrast.

These imaging agents enabled the researchers to determine the presence of pathology that cannot be visualised using conventional imaging techniques. They also offer advantages over (i) large monomeric particles that can cause microvessel blockage and (ii) small particles that are often rapidly cleared from the target site.

## Early detection of brain metastasis

Brain metastasis is one of the greatest hurdles in cancer therapy; 20-40% of all cancer patients will suffer metastatic spread of primary cancer to the brain, and the prognosis is poor. Tumour cells use cellular adhesion molecules, normally associated with leukocyte trafficking, to metastase to non-CNS sites. Although leukocyte recruitment to the brain is atypical, exploratory research has shown the endothelial cells lining the vessels still express cellular adhesion molecules.

The researchers have developed an imaging agent using the new generation of imaging agents in conjugate with

a humanised anti-VCAM antibody as a non-hazardous antibody-drug conjugate (ADC) for intravenous delivery. The imaging agents and the ADC are being supported by two MRC DPFS awards, which will take these agents through pre-clinical toxicology and a Phase I trial. The team have demonstrated that this ADC allows very early detection of brain metastasis – secondary cancer in the brain.

## Patent Protection

Patent applications for the imaging agents are granted in Europe and USA, and patent applications for the antibody-drug conjugate are in national phase in Europe, Canada and USA.

Oxford University Innovation is looking to licence these agents for further development beyond Phase I.

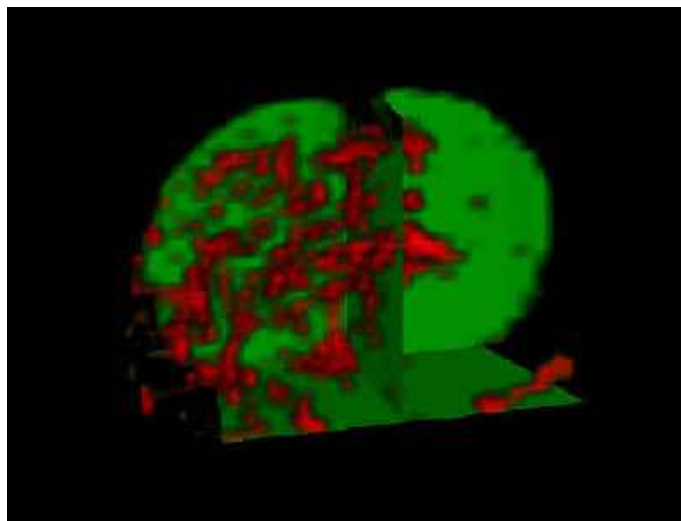

For further information please contact:

Dr Sarah Deakin

[sarah.deakin@innovation.ox.ac.uk](mailto:sarah.deakin@innovation.ox.ac.uk)

+44 (0)1865 614410

[www.innovation.ox.ac.uk](http://www.innovation.ox.ac.uk)

Project number: 2924, 6596

## Technology Transfer from the University of Oxford

The information in this Project Profile is provided "as is" without conditions or warranties and Oxford University Innovation makes no representation and gives no warranty that it is the owner of the intellectual property rights in the technology described.

# Improved inflammation imaging



Available to license: Lewis-sugar based MRI contrast agents

The new agents provide excellent diagnostic images for inflammatory diseases, enabling faster and more accurate diagnosis.

Imaging techniques – including MRI, PET and Ultrasound – are employed for the diagnosis and staging of disease. Contrast agents are used in imaging to increase the signal difference between the area of interest and background. Such agents can be divided into two general categories, those passive agents which non-specifically enhance the signal that is produced and targeted contrast agents which are chemically modified in order to localise to a specific cell type or tissue through an active mechanism. Passive agents are most widely used, but reflect downstream pathology.

Targeted agents, by contrast, can reveal the earliest of changes associated with disease development by virtue of their ability to recognise molecular changes in a particular cell or tissue that precede changes in tissue structure. Such targeted agents overcome the difficulties of high background signal in order to provide a clear picture for the clinician. There is a need for improved contrast agents that can be targeted to cell surface receptors to enhance imaging techniques.

## Oxford invention

Oxford researchers have found that novel Lewis-type sugars can recognise and bind to activated endothelial cells *in vivo*. Furthermore, when conjugated to a suitable imaging moiety, e.g. an MRI-active material, the conjugate enables the activated endothelium to be visualised.

## Benefits of this approach

Oxford researchers have used their invention to generate new imaging agents to diagnose diseases associated with endothelial activation including inflammatory diseases such as MS & atherosclerosis. The conspicuity of these conjugates is significantly improved compared with known passive or targeted imaging agents. The use of well-conserved sugars enables species boundaries to

be easily crossed and these sugars are much easier to produce than previously used targeting moieties.

## Patent protection and commercial opportunities

The underlying technology is the subject of an International Patent Application. There are several other complementary targeted imaging projects which have been developed at Oxford:

- Project 2468 , Sugar-targeted imaging agent
- Project 2924, Biodegradable multimeric iron oxide particles
- Project 6596, Humanised monoclonal antibodies to VCAM-1

Companies interested in progressing the commercial opportunities are invited to contact Oxford University Innovation.



For further information please contact:

Dr Jamie Ferguson  
jamie.ferguson@isis.ox.ac.uk  
+44 (0)1865 280851  
www.innovation.ox.ac.uk  
Project number: 9030

## Technology Transfer from the University of Oxford

The information in this Project Profile is provided "as is" without conditions or warranties and Oxford University Innovation makes no representation and gives no warranty that it is the owner of the intellectual property rights in the technology described.

Oxford researchers have developed advanced software for analysing images of the brain.

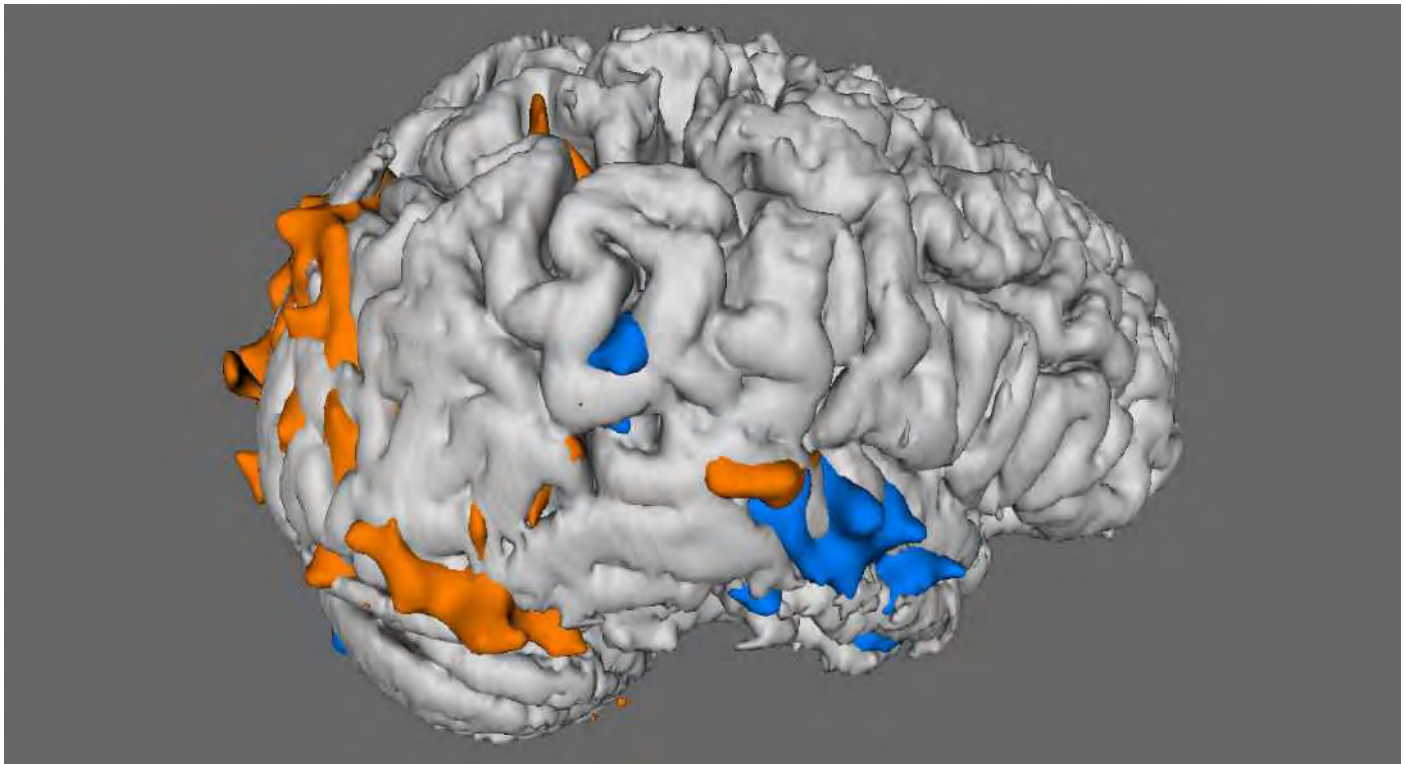

## Functional MRI

- FEAT is a software tool for high quality model-based fMRI data analysis, with an easy-to-use graphical user interface (GUI). FEAT automates as many of the analysis decisions as possible, and allows easy (though still robust, efficient and valid) analysis of simple experiments whilst giving enough flexibility to also allow sophisticated analysis of the most complex experiments.

## Structural MRI

- BET (Brain Extraction Tool) deletes non brain tissue from an image of the whole head. Can also estimate inner and outer skull surfaces.
- FLIRT (FMRIB's Linear Image Registration Tool) and FNIRT (FMRIB's Non-linear Image Registration Tool) is a fully automated robust and accurate tool for linear and non-linear intra- and inter-modal brain image registration.
- FAST (FMRIB's Automated Segmentation Tool) segments a 3D image of the brain into different tissue types (Grey Matter, White Matter, CSF, etc.), whilst also correcting for spatial intensity variations (also known as bias field or RF inhomogeneities).

## Diffusion MRI

- Eddy- a tool for correcting eddy currents and movements in diffusion data. Simultaneously models

the effect of diffusion eddy currents and movements on the image.

- Topup- A tool for estimating and correcting susceptibility induced distortions
- Eddyqc- The QC metrics are derived through different stages of FSL's pre-processing tools (TOPUP and EDDY). Using this framework it is possible to distinguish between good and bad quality datasets and, importantly, identify subsets of the data that may need careful visual inspection

## GLM/Stats

- FSLeyes (pronounced fossilise) is the new FSL image viewer, released with FSL 5.0.10
- BayCEST- Bayesian analysis for chemical exchange saturation transfer z-spectra. BayCEST exploits a Bayesian non-linear fitting algorithm, providing a (relatively) fast means to quantify CEST data.

The full list of available technologies can be accessed here: <https://fsl.fmrib.ox.ac.uk/fsl/fslwiki/>

For further information please contact:  
[fsl@innovation.ox.ac.uk](mailto:fsl@innovation.ox.ac.uk)  
Project number: 9564

## Technology Transfer from the University of Oxford

The information in this Project Profile is provided "as is" without conditions or warranties and Oxford University Innovation makes no representation and gives no warranty that it is the owner of the intellectual property rights in the technology described.

# Improved quantification of arterial blood-flow



Available to license: MRI methods enabling the quantification of blood-flow through small vessels without the need for contrast agents.

Angiographic methods which generate images of blood vessels and provide information on vessel morphology and function.

## Imaging blood flow

Many angiographic methods only provide qualitative information on blood flow, making objective comparisons between vessels and different patients difficult. In addition, these methods have a number of drawbacks such as the requirement for an invasive procedure, the use of ionizing radiation, and the administration of a contrast agent.

Quantification of blood flow rates from dynamic images have been demonstrated, but typically can only be applied to the larger arteries. Oxford scientists have improved existing quantification by allowing measurements to be made in smaller arteries and arterial segments in a robust manner.

## Oxford Invention

The Oxford invention incorporates region-based angiographic methods for the quantification of blood flow rates from dynamic angiography data.

The methods offer several improvements over existing techniques:

- Ability to provide data on all vessels in a group together or to provide vessel-selective information
- Less computation time required, enabling improved patient throughput
- Easier to implement on MRI apparatus for use by clinicians
- Blood flow can be estimated on a finer scale allowing detailed quantification of blood-flow along an entire arterial vascular tree in the brain of a subject.

## Applications

Improved quantification of blood flow could assist in the management of:

- Atherosclerosis – imaging of narrowing in small vessels
- Stroke – quantification and assessment of disease state
- Cancer – improved assessment of tumour perfusion to improve treatment planning

## Patent protection

A patent protecting the methods developed has been filed and software for conducting this work has been coded. Methods have been demonstrated in model flow phantoms and in healthy human volunteers.



For further information please contact:  
**Dr Chandra Ramanujan**  
[chandra.ramanujan@innovation.ox.ac.uk](mailto:chandra.ramanujan@innovation.ox.ac.uk)  
**+44 (0)1865 614434**  
[www.isis-innovation.com](http://www.isis-innovation.com)  
**Project number: 11771**

## Technology Transfer from the University of Oxford

The information in this Project Profile is provided "as is" without conditions or warranties and Isis makes no representation and gives no warranty that it is the owner of the intellectual property rights in the technology described.

**Available to license:** Quicker and more robust image registration software for (S)TEM images

Researchers at the University of Oxford have developed a software tool for the precise compensation of image offsets and scanning distortions.

## Motion sickness

The 'Smart Align' software delivers superior image processing, enhancement and quantification in dark- and bright-field scanning transmission electron microscopy (STEM), conventional TEM registration and scanning tunnelling microscopy (STM). It requires very little human intervention. The software uses a weighted learning filter to guide the rigid-registration stage. Built-in knowledge describes the scanning nature of the serial acquisition and reduces artefact introduction. A mature demo version is available for assessment.

## Automated registration

STEM data is recorded serially and acquisition times can be tens of seconds long. At these acquisition times stage/sample drift and low frequency distortions can perturb the image locally. Often the first step in any quantitative interpretation of STEM data is to correct for these drifts and distortions using so-called rigid and non-rigid registrations respectively. The Oxford invention is an improved automated method of performing this registration step, customised for the challenges unique to STEM data. The improvements developed address the challenges of registering images which contain a large proportion of crystalline material and/or local features of interest such as dislocations or edges.

## Demonstration available

'Smart Align' uses a new learning mode for rigid registration of images dominated by periodic (crystallographic) features and a 'row-locking' mode for artefact free non-rigid registration of serially acquired data. It includes novel options designed with EM image processing in mind. The software has

been rigorously tested and developed to a mature demonstration version.

## Superior results

The Oxford invention enables processing and enhancement of microscopy images, delivering superior results and quantification compared with current methods. Through built-in knowledge and a weighted learning filter this is achieved with very little human input. The technology has been specifically developed for the analysis of dark-field scanning transmission electron microscopy images, but can be used with bright-field data, conventional TEM and in other image analysis applications.

Oxford University Innovation welcomes contact from parties interested in licensing this opportunity.

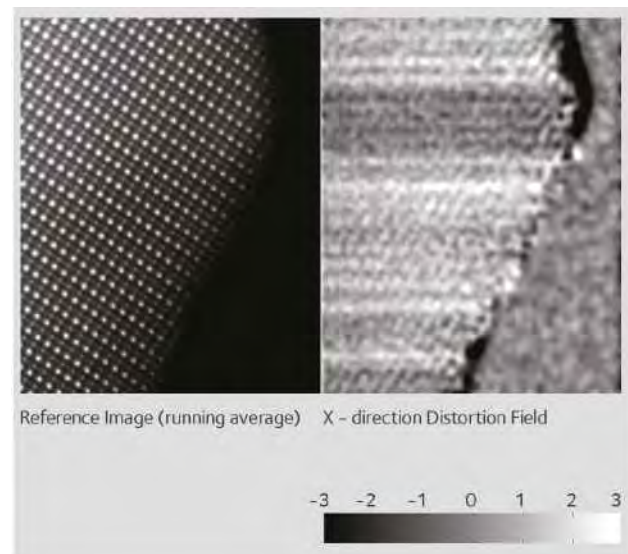

For further information please contact:  
Dr Chandra Ramanujan  
[chandra.ramanujan@innovation.ox.ac.uk](mailto:chandra.ramanujan@innovation.ox.ac.uk)  
+44 (0)1865 614434  
[www.innovation.ox.ac.uk](http://www.innovation.ox.ac.uk)  
Project number: 11341

## Technology Transfer from the University of Oxford

The information in this Project Profile is provided "as is" without conditions or warranties and Oxford University Innovation makes no representation and gives no warranty that it is the owner of the intellectual property rights in the technology described.

# Off-resonance correction method for magnetic resonance perfusion imaging and angiography



Available to license: A novel method to correct for the effects of off-resonance (magnetic field inhomogeneity) with no loss of signal-to-noise ratio and without additional scan time.

Oxford researchers have developed a method for correcting off-resonance effects present in Arterial Spin Labelling (ASL) Magnetic Resonance Imaging (MRI).

## Invasive perfusion imaging and angiography – a less than ideal gold standard

Perfusion imaging provides qualitative and quantitative information on blood flow whilst angiographic methods generate images of blood vessels. Both perfusion imaging and angiography are of great importance in the assessment of vascular diseases by providing information on the function and health of tissue and blood vessels in the brain. This knowledge aids clinicians with diagnosis, prognosis and treatment planning in these patients.

Most MRI methods for acquiring perfusion information involve administering a gadolinium based contrast agent, which have been linked to nephrogenic systemic fibrosis in patients with kidney dysfunction. Additionally, X-ray digital subtraction angiography is the gold standard for acquiring vessel-specific angiographic information; however, this requires both the insertion of a catheter to administer a contrast agent and the use of ionizing radiation. Associated risks to the patient include strokes or transient ischemic attacks.

## Magnetic resonance imaging – reduced risk for patients

MRI techniques, such as Pseudo-Continuous Arterial Spin Labelling (PCASL) and vessel-encoded PCASL (VEPCASL) are powerful, non-invasive methods available to clinicians to acquire perfusion data and angiograms in the brain without the use of contrast agents. VEPCASL allows acquisition of vascular territory maps and vessel-selective angiograms.

VEPCASL has an advantage over other vessel-selective methods in that it allows vessels to be labelled that are closer together. However, off-resonance (magnetic field inhomogeneity) in the labelling plane can occur in either case, leading to a reduction in labelling efficiency and thus image quality.

Current methods for off-resonance correction are limited, with some requiring additional PCASL scans and/or manual intervention to calculate the corrections needed.

## Key features and commercialisation

- Simple to implement
- Based on generating an Optimised Encoding Scheme (OES)
- Applicable to any pattern of off-resonance and any number of vessels
- Works with both conventional PCASL and VEPCASL

A provisional patent application has been filed in the USA. Oxford University Innovation are seeking partners in the MRI software and /or hardware space to commercialise this technology.

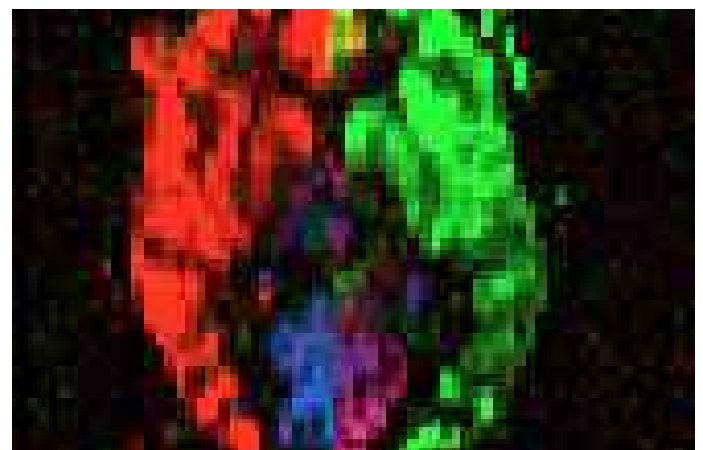

For further information please contact:  
**Dr Chandra Ramanujan**  
[chandra.ramanujan@innovation.ox.ac.uk](mailto:chandra.ramanujan@innovation.ox.ac.uk)  
**+44 (0)1865 614434**  
[www.innovation.ox.ac.uk](http://www.innovation.ox.ac.uk)  
**Project number: 12191**

## Technology Transfer from the University of Oxford

The information in this Project Profile is provided "as is" without conditions or warranties and Oxford University Innovation makes no representation and gives no warranty that it is the owner of the intellectual property rights in the technology described. 46



# Post-processing deblurring for medical imaging



**Available to license:** Providing a post-processing method for the de-blurring based on the data alone

University of Oxford scientists have created a post-processing method for reducing the effects of blurring introduced in MRI images when acquired using a '3D' readout



## Correcting image blurring after acquisition

Blurring is often seen in a particular direction in images from certain 3D readouts. Solutions typically require the 'segmentation' of the readout, which increases the overall image acquisition time substantially.

Oxford scientists have developed methods to provide correction to the data after acquisition - it can thus be applied retrospectively where blurring has already occurred and prospectively where segmentation is not desirable, or only partial segmentation is possible

The method attempts to use the noise on the data to estimate the degree of blurring and derive a kernel that can be used to undo the blurring process. The developed method is specifically for application to MRI data taking into account the special nature of the MRI acquisition process.

## Further applications

To date, the method developed has been applied to Arterial Spin Labelling (ASL) perfusion MRI, however in principle the method might be applicable to a wide range of MRI methods that rely upon '3D' readout.

## Development status and commercialisation

Code which has been tested on existing human data is available to apply the deblurring techniques to 3D-images. Isis Innovation seeks parties interested in licensing this software.

**For further information please contact:**

**Dr Chandra Ramanujan**

[chandra.ramanujan@innovation.ox.ac.uk](mailto:chandra.ramanujan@innovation.ox.ac.uk)

+44 (0)1865 614434

[www.innovation.ox.ac.uk](http://www.innovation.ox.ac.uk)

Project number: 12409

## Technology Transfer from the University of Oxford

The information in this Project Profile is provided "as is" without conditions or warranties and Oxford University Innovation makes no representation and gives no warranty that it is the owner of the intellectual property rights in the technology described. 47

# High throughput image analysis platform for 3D cellular tissues



**Available to license:** A high throughput image analysis platform for 3D cellular tissues using optical microscopy images and new robust probabilistic segmentation methods.

## High throughput analysis of highly complex 3D cellular tissues from optical microscopy images

Automated protein distribution spatial analysis within cellular tissues becomes challenging when looking at highly complex 3D tissues, due to difficulties with segmentation of low resolution optical microscopy images that contain densely packed cellular features.

Using a robust probabilistic tissue segmentation method, the proprietary University of Oxford platform SilentMark, enables high throughput analysis of complex 3D cellular tissues from noisy and difficult to segment optical microscopy images.

Protein fluorescence levels can be quantified in the different sub-cellular compartments, to facilitate the systematic analysis of protein localization under a diverse range of experimental conditions.

## Tested in the analysis of 3D tissues of varying complexity

The proprietary University of Oxford platform has a graphical user interface and has been tested in the context of developing tissues where initially low cellular density geometrically simple structures transform into high cellular density geometrically complex structures.

The tissues on which the software has been tested include mouse stem cell embryoid bodies and mouse cardiomyocytes during heart development, tissues comprising from 2 to an estimated 2,000 cells respectively.

## Applications in tissue engineering and drug screening

The platform is the first of a kind to provide quantitative three dimensional protein information for developing tissues across multiple organisms. This is particularly relevant where quantitative statistical analysis of protein organisation and gene expression lays the foundation for high throughput cancer research, tissue engineering, and drug screening.

Oxford University Innovation would like to talk to companies or end-users wanting to license or make use of this proprietary University of Oxford software.

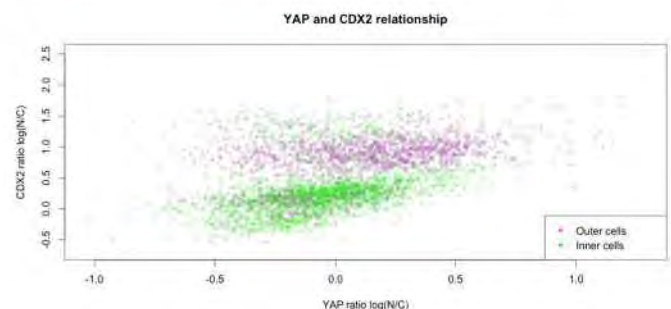
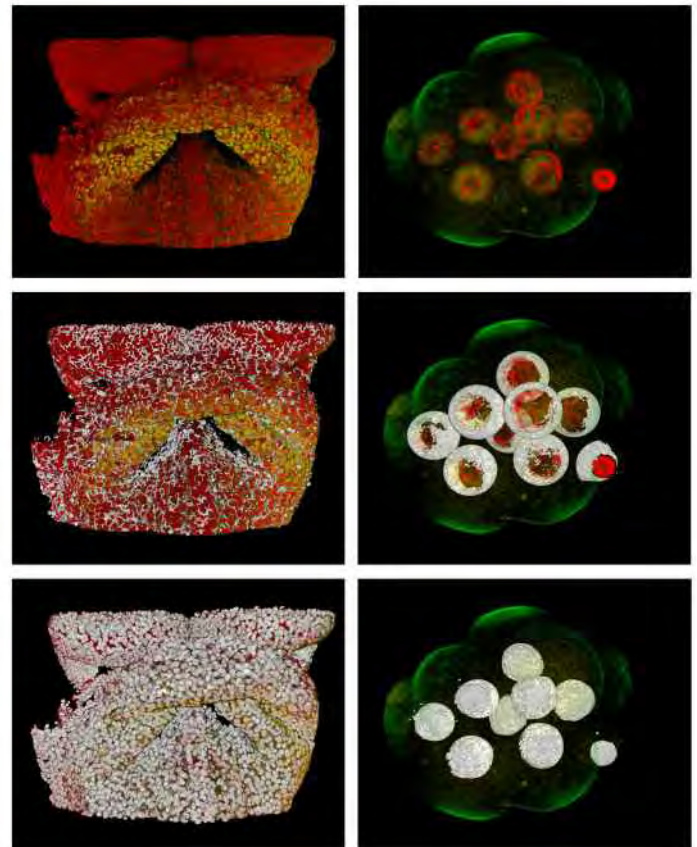

For further information please contact:

Dr Richard Auburn

Richard.Auburn@innovation.ox.ac.uk

+44 (0)1865 280956

www.innovation.ox.ac.uk

Project number: 13299

## Technology Transfer from the University of Oxford

The information in this Project Profile is provided "as is" without conditions or warranties and Oxford University Innovation makes no representation and gives no warranty that it is the owner of the intellectual property rights in the technology described.

# EM∩IM – Correlating Electron Microscopy (EM) and Ion Mobility (IM) spectra



Oxford researchers have developed EM∩IM, a piece of software capable of accurately calculating Collisional Cross Sections from Electron Microscopy (EM) density maps correlated with Ion mobility data.

## Collisional Cross Sections (CCSs)

Ion mobility (IM) experiments measure the travel time of a molecule through a tube of inert gas. Collisions with the gas slow the molecule and increase the travel time. The larger the collisional cross section (CCS) of the molecule, the more collisions will occur.

However, for particularly large or flexible molecules, this “average surface” modelling technique can be inaccurate. To analyse such proteins, scientists often turn to Electron Microscopy, which can provide an electron density map with near-atomistic definition.

## Following the map

Although electron density maps can provide information ranging from coarse shape to molecular structure, determination of CCSs from this data has not been possible. Researchers at the University of Oxford have developed EM∩IM, software capable of processing electron density maps to calculate collisional cross sections. This breakthrough enables rationalisation of a completely new range of protein targets.

## EM∩IM

The EM∩IM software package works by modelling the electron density map, obtained from EM experiments, as a collection of tightly packed spheres (isosurface).

Another piece of Oxford software (IMPACT) is then used to calculate a collisional cross section from the model. This methodology produces a number of possible CCSs, but it is accurately determined by correlation to protein mass.

We believe the main benefits of this approach to be as follows:

- Calculation of CCSs from electron density maps
- Allows analysis of larger, more flexible protein targets
- Correlates IM, EM and CCS data
- Permits validation of IM-MS data where this is possible

## Copyright protection

The software is currently free to download for academic users; however Oxford University Innovation Ltd. is also seeking potential commercial users.

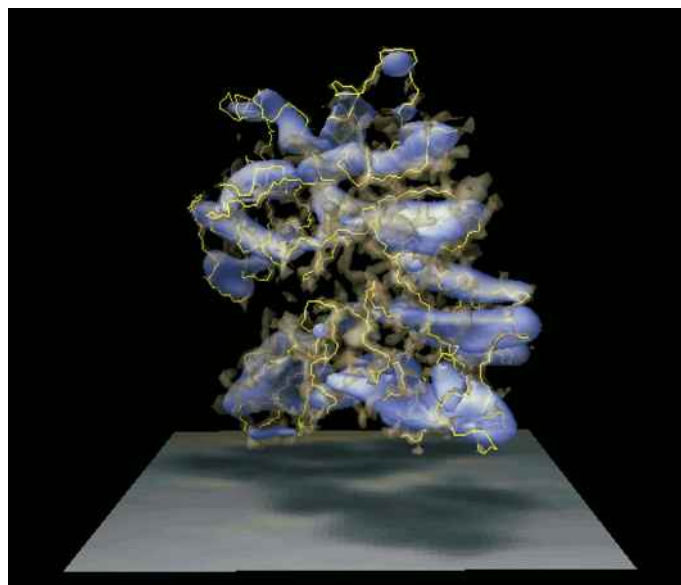

For further information please contact:

Dr Richard Auburn

[richard.auburn@innovation.ox.ac.uk](mailto:richard.auburn@innovation.ox.ac.uk)

+44 (0)1865 280956

[www.innovation.ox.ac.uk](http://www.innovation.ox.ac.uk)

Project number: 13366

## Technology Transfer from the University of Oxford

The information in this Project Profile is provided "as is" without conditions or warranties and Oxford University Innovation makes no representation and gives no warranty that it is the owner of the intellectual property rights in the technology described.

# Correcting imaging artefacts due to bidirectional scanning



Oxford researchers have developed a post-acquisition image processing technique that enables fast-high resolution acquisition of bidirectional scanning data.

## Processing of high-speed acquired dynamic images

Laser scanning microscopy is a powerful technique used by scientists and researchers to improve their ability to view dynamic images. The faster an image can be generated, the wider the variety of biological processes that can be observed.

Particularly in dynamic samples, geometrical distortion is one of the biggest issues of bidirectional image acquisition and it is caused by the variable motion of the flatbed scanning laser.

Currently, there is a need to process images obtained by fast scanning to make accurate measurements with low error bounds.

## The technology

Researchers at the University of Oxford have developed a method, based on the combination of two image processing techniques. This enables fast removal of movement artefacts and lessens the distortion caused by laser scanning. This post-acquisition image analysis technique can be applied to different scanning protocols and it enables the use of fast scanning techniques while obtaining distortion-free images.

## Image-based artefact removal in microscopy

Laser movement-based distortion has been highlighted as an issue in the imaging of biological samples obtained by laser scanning microscopy. This has been established as a first potential application and the image processing technique has been validated in the analysis of dynamic biological samples.

As a result, it has been shown that the Oxford framework enables reconstruction of distortion-correct images from acquired distorted images, allowing the monitoring of complex, dynamic processes, such as tumour growth, without sacrificing spatial and temporal resolution.

## Additional applications include satellite image acquisition

The method developed at the University of Oxford can also estimate displacement caused primarily by the varying speed of the laser during bidirectional data scanning and can be used to compare different acquisition systems quantitatively.

The technique can be applied to any sector requiring fast-acquisition images, including for example:

- Satellite image acquisition
- Naval positioning
- LIDAR systems

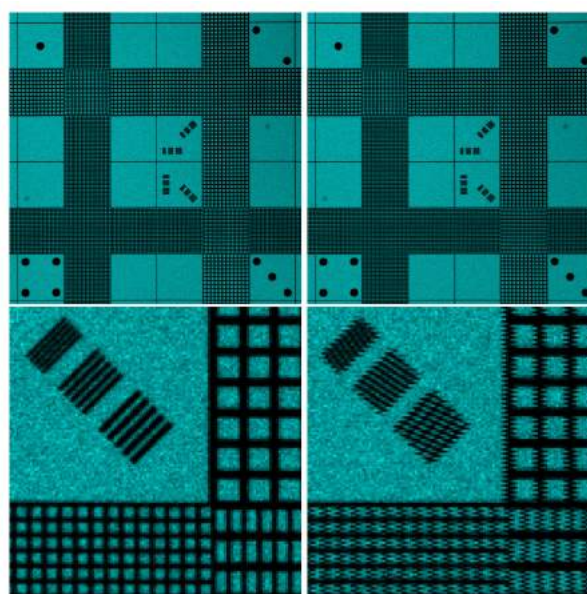

Image: (top left) Image obtained by unidirectional line acquisition, together with zoom (bottom left); (top right) image obtained for the bidirectional line acquisition together with zoom (bottom right). The image obtained by bidirectional line acquisition shows severe jaggedness artefacts for every second line occurring in the correspondence to the speed of microscope laser.

**For further information please contact:**

**Iraida Soria Espinosa**

**[iraida.soriaespinosa@innovation.ox.ac.uk](mailto:iraida.soriaespinosa@innovation.ox.ac.uk)**

**+44 (0)1865 6 14453**

**[www.innovation.ox.ac.uk](http://www.innovation.ox.ac.uk)**

**Project number: 14289**

## Technology Transfer from the University of Oxford

The information in this Project Profile is provided "as is" without conditions or warranties and Oxford University Innovation makes no representation and gives no warranty that it is the owner of the intellectual property rights in the technology described.

Oxford researchers have developed the first [<sup>18</sup>F]-labelled olaparib, thus allowing *in-vitro* and *in-vivo* monitoring of olaparib accumulation in tumours.

## PARP inhibitors in anticancer therapy

Tumorous tissues are characterised by having genomic instability due to replicative stress, external genotoxicity and DNA repair defects. The manipulation of such instability provides a therapeutic space in which inhibitors of DNA damage repair (DDR) enzymes have been studied as anti-cancer drugs. Poly (ADP-ribose) polymerase (PARP) are a class of DDR enzymes, and its inhibition has been the subject of numerous studies. The first clinically approved and most studied PARP inhibitor is olaparib (Lymparza®), currently present in a plethora of clinical trials focused on its use as a single drug, or in combination with chemo-, immuno-, or radiation therapy.

Despite the therapy being highly successful, resistance to PARP inhibition remains a current challenge when applying the therapy to patients. Among the causes, it was found that resistance is often due to low PARP enzyme expression. Consequently, methods to evaluate PARP expression status in tumours are critical; however, current approaches remain invasive and might not fully represent the heterogeneity of the sample.

## Measurement of PARP expression

Positron emission tomography (PET) has become highly popular as an alternative method to measure PARP expression *in vivo*, as it allows for a non-invasive, whole-body and repeatable visualisation of olaparib delivery and binding to PARP. Several radiolabelled olaparib derivatives have been developed and applied in the understanding of DDR mechanism; however, their structural deviation from their parent molecule makes them unsuitable for further development.

## [<sup>18</sup>F]olaparib for PET imaging

Oxford researchers have applied their expertise on novel radiofluorination methods and synthesised the first [<sup>18</sup>F]-labelled olaparib from a bench stable precursor. This “hot” compound has an identical structure to the unlabelled version meaning that better data can be gathered about the fate of olaparib *in vivo* compared to

those labelled analogues which use large linker moieties or surrogates.

*In vitro* and *in vivo* translation of [<sup>18</sup>F]olaparib includes:

- Dynamic monitoring of bio-distribution and uptake
- Pharmacokinetics and clearance patterns studies
- Measurement of PARP binding
- Detection and monitoring of DNA damage
- Study of the relationship between hypoxia and PARP expression

In summary, [<sup>18</sup>F]olaparib was shown to be highly valuable in quantifying olaparib tumour accumulation both *in vitro* and *in vivo*, thus enforcing its translational use as a PARP imaging agent for clinical PET.

## Protection and Applications

Oxford University Innovation is currently seeking a licensee to help commercialise the technology and has filed a UK priority patent application to protect this innovation.

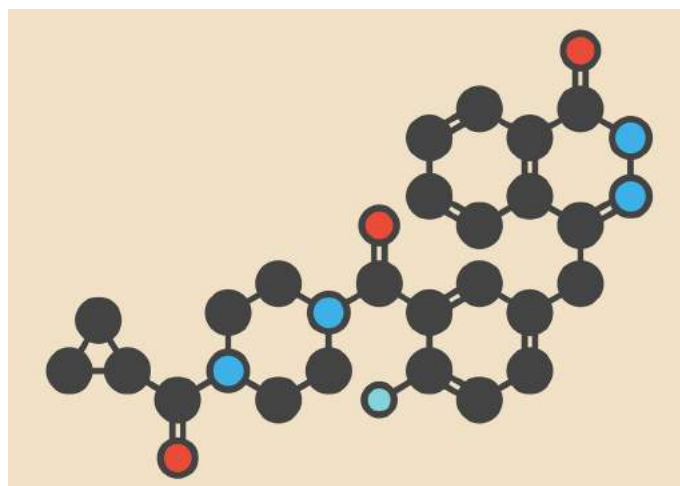

For further information please contact:

Jane Jin

Jane.Jin@innovation.ox.ac.uk

+44 (0)1865 280846

www.innovation.ox.ac.uk

Project number: 15151

## Technology Transfer from the University of Oxford

The information in this Project Profile is provided "as is" without conditions or warranties and Oxford University Innovation makes no representation and gives no warranty that it is the owner of the intellectual property rights in the technology described.

# Graphene based sensor system compatible with MRI and CT imaging



Researchers at the University of Oxford have developed a novel graphene-based piezoelectric sensor that is compatible with both MRI and CT imaging.

## Body motion monitoring in MRI and CT imaging

Magnetic resonance imaging (MRI) and computerised tomography (CT) scanners are widely used to produce high resolution images of the human and animal anatomy. Due to the high magnetic fields and X-ray radiation used in MRI and CT scanning, respectively, there are significant limitations on the materials that may be placed inside the scanner.

Stable and high-resolution MRI and CT images with minimum artefacts can only be obtained when the effects of body motion are minimised. This is achieved by monitoring both cardiac and respiratory cycles and synchronising the image acquisition with this motion. Respiratory monitoring in small animal imaging is typically achieved with a respiratory balloon, a device that measures the change of air pressure within a capsule placed in contact with the abdomen. Limitations of this method include:

- The need for careful placement and calibration of the device
- Repressurisation and calibration if the animal is transferred between systems, a major drawback when changes in posture must be minimised

An alternative technique for respiratory monitoring uses piezoelectric sensors – devices which use a piezoelectric polymer to convert deflection into an electrical signal. Metallic thin films are deposited on both sides of the polymeric component for signal collection. Both calibration and setup are simple, and the device is insensitive to air pressure, however these sensors have not found widespread use as the metallic films have detrimental consequences for the images produced by both scanning techniques.

## Graphene-based piezoelectric sensors

Researchers at Oxford have tackled this limitation and developed a **piezoelectric sensor compatible with MRI and CT imaging**.

Metal has been replaced by thin layers of graphene, providing the following advantages:

- Radiolucency
- Minimal distortion to magnetic fields
- High in-plane conductivity
- High mechanical flexure and strain resilience
- Transparency

In addition, graphene technology has the potential to be used in a wide range of electronic components for MRI and CT imaging systems, thus creating many opportunities **for graphene-based systems in MRI and CT sensing and diagnostics**.

## Commercialisation

Oxford University Innovation Ltd. has filed a priority patent application on the technology and welcomes discussions with companies interested in licensing it for commercial development.



For further information please contact:  
[technology@innovation.ox.ac.uk](mailto:technology@innovation.ox.ac.uk)  
+44 (0)1865 280832  
[www.innovation.ox.ac.uk](http://www.innovation.ox.ac.uk)  
Project number: 15727

## Technology Transfer from the University of Oxford

The information in this Project Profile is provided "as is" without conditions or warranties and Oxford University Innovation makes no representation and gives no warranty that it is the owner of the intellectual property rights in the technology described.

# A new method for automated 3D blood vessel reconstruction



Oxford researchers have developed a new algorithm for robust and accurate reconstruction of 3D vessel trees from multiple retrospective angiographic projections.

## Angiography and its limitations

X-ray angiography is the most commonly used imaging modality for the visualisation of coronary blood vessels. Its advantages include simplicity, high spatial and temporal resolution of lumen structure, and most importantly, its utility to guide coronary interventions in real time. However, despite these clinical advantages, X-ray angiograms pose several challenges, especially in relation to visualising lesions adequately and judging lesion severity.

The 2D projections of the 3D vascular structure in different image planes produce vessel overlap and foreshortening and hence, make it difficult for the cardiologists to interpret the geometry of the object. This leads to high inter- and intra-observer variability in understanding the global anatomical structure and, in turn, affects the accuracy of the estimation of lesion severity and stent size.

The interpretation gets further complicated due to the existence of several motion artifacts, including cardiac, respiratory, and patient or device movement that occur during the acquisition. In addition, potential adverse effects of higher amount of radiographic contrast agent and exposure to X-rays limit the number of image acquisitions.

## The Oxford solution

Several methods have been developed to extract 3D images from the 2D angiograms, but they have several limitations. While some of them require specific acquisition protocols to be applied when registering the images (breath-hold, no patient movement, etc.), others are only applicable on biplane angiograms and do not involve any motion correction or geometry calibration step.

Oxford researchers have developed a new algorithm using a novel point-cloud approach for robust and accurate reconstruction of 3D blood vessel trees, while removing all motion artifacts. This novel method can be applied to retrospective images and is able to reconstruct specific vascular structures.

## Potential applications

This new algorithm has been developed and validated for application on coronary angiograms, but it can be applied to reconstruct other 3D structures, including brain vessels. Additionally, this novel method could enable the amalgamation of angiography and MRI assessment and therefore, would improve the current diagnostics, since at present there is no way to compare severity of the blood obstruction (angiography) and muscle injury (MRI) in the clinic.

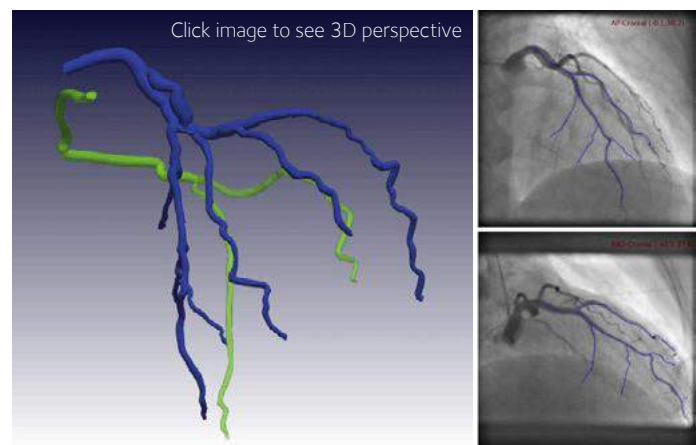

**Left:** Reconstructed 3D coronary arterial tree from 2D angiographic projections. **Right:** 2D angiographic projections of left coronary artery, along with the reprojection of reconstructed 3D centerline of left anterior descending artery (in blue).

**For further information please contact:**  
**Dr Chandra.Ramanujan**  
[Chandra.Ramanujan@innovation.ox.ac.uk](mailto:Chandra.Ramanujan@innovation.ox.ac.uk)  
**+44 (0)1865 614434**  
[www.innovation.ox.ac.uk](http://www.innovation.ox.ac.uk)  
**Project number: 16185**

## Technology Transfer from the University of Oxford

The information in this Project Profile is provided "as is" without conditions or warranties and Oxford University Innovation makes no representation and gives no warranty that it is the owner of the intellectual property rights in the technology described.



# METABOLIC DISEASES



# UKPDS Cardiovascular Risk Engine - Version 3



Available to license: Type 2 diabetes-specific cardiovascular risk calculator based on 53,000 UKPDS patient-years of data that can be used to educate and inform across the diabetes care landscape.

The UKPDS Risk Engine, developed by researchers at the University of Oxford, is a type 2 diabetes-specific risk calculator that will support a wide range of health care professionals in educating and managing the care of patients with type 2 diabetes

## The risk engine

Cardiovascular disease is a significant complication in type 2 diabetes and is responsible for 62% of the 2.2 million disease-related deaths which occur each year. Therefore, it is critical that we are able to understand the relationship between present day risk factors and future cardiovascular disease outcomes, both in terms of patient education and healthcare planning.

To address this issue, a team led by Prof Rury Holman at the Oxford Centre for Diabetes, Endocrinology and Metabolism have developed a type 2 diabetes-specific risk calculator. Based on 53,000 patient-years of data from the UK Prospective Diabetes Study, the software provides risk estimates and 95% confidence intervals for individual patients with type 2 diabetes to develop cardiovascular disease. The risk of developing non-fatal or fatal coronary heart disease or stroke can be measured for any given disease duration based on a variety of factors including:

- Age
- Sex
- Ethnicity
- Smoking status
- Presence or absence of atrial fibrillation and levels of HbA1c
- Systolic blood pressure
- Total cholesterol
- HDL cholesterol

## Applications

The UKPDS Risk Engine is of value to healthcare providers in educating and managing the care of patients with type 2 diabetes, as well as to the pharmaceutical industry in educating physicians, payers and prescribers regarding the benefits of positive

lifestyle changes and optimal blood glucose control.

The UKPDS Risk Engine will furthermore be of value to insurance companies, healthcare service planners and providers.

## Software status

The software is currently available for both commercial and academic use in the form of a standalone application for Microsoft Windows, Apple Mac, Palm and Pocket PC platforms. An Excel worksheet version is available on Microsoft and Apple Mac. The software is also available for incorporation in other software packages as an ActiveX module or as a Apple Mac shared library. For further information, and to review academic use licence terms, please visit:

[www.dtu.ox.ac.uk/riskengine/](http://www.dtu.ox.ac.uk/riskengine/)

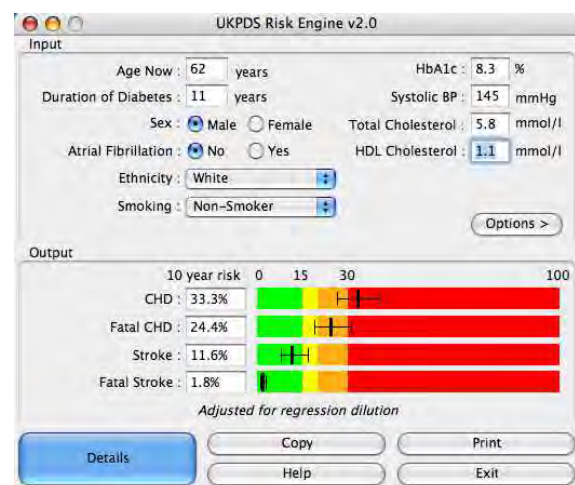

For further information please contact:

Dr James Groves

[james.groves@innovation.ox.ac.uk](mailto:james.groves@innovation.ox.ac.uk)

+44 (0)1865 614425

[www.innovation.ox.ac.uk](http://www.innovation.ox.ac.uk)

Project number: 8949

## Technology Transfer from the University of Oxford

The information in this Project Profile is provided "as is" without conditions or warranties and Oxford University Innovation makes no representation and gives no warranty that it is the owner of the intellectual property rights in the technology described.

# Glycaemic variability calculator



**Available to license:** A tool for diabetes researchers

EasyGV is an Excel spreadsheet that calculates glycaemic variability of blood glucose profiles. It puts 10 different methods into one convenient, easy to use tool.

## Glycaemic variability

Glycaemic variability is the fluctuation of glucose levels in the human body. In diabetic patients, the level of fluctuation may have an impact on disease complications, and is an area of ongoing clinical research.

## The Oxford technology

EasyGV is a macro-enabled Excel workbook and has been tested with Microsoft Excel versions 2007, 2010 and 2011. EasyGV allows you to calculate 10 different measures of glycaemic variability (GV) from continuous glucose monitoring data using a simple interface.

The GV Methods available are:

- M-Value
- Mean Amplitude of Glycaemic Excursions
- Lability Index
- Average Daily Risk Range
- J-Index
- Low Blood Glucose Index & High Blood Glucose Index
- Continuous overall net glycaemic action
- Mean of Daily Differences
- Glycaemic Risk Assessment Diabetes Equation
- Mean Average Glucose

## Supporting information

An academic paper is available, with more information:

<http://www.ncbi.nlm.nih.gov/pmc/articles/PMC3160264/>

## Technology status

Oxford University Innovation welcomes interest from companies interested in licensing the technology.

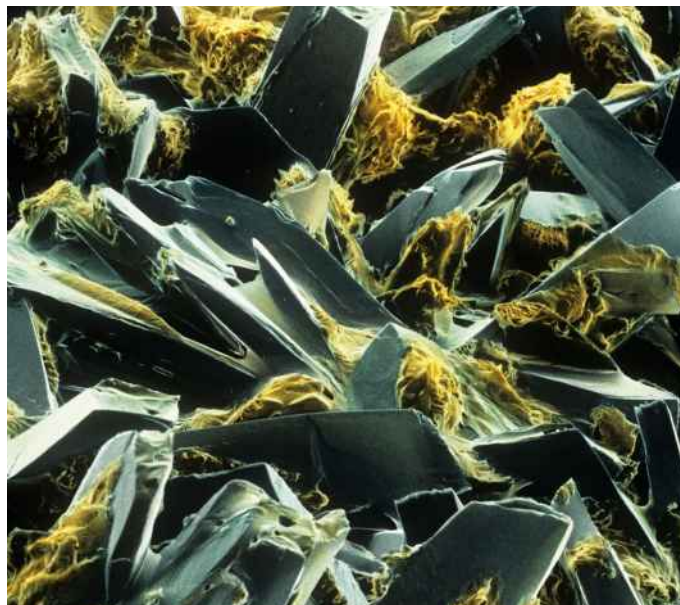

**Image:** False colour SEM of glucose crystals

**For further information please contact:**

**Dr James Groves**  
[james.groves@innovation.ox.ac.uk](mailto:james.groves@innovation.ox.ac.uk)  
**+44 (0)1865 614425**  
[www.innovation.ox.ac.uk](http://www.innovation.ox.ac.uk)  
**Project number: 9797**

## Technology Transfer from the University of Oxford

The information in this Project Profile is provided "as is" without conditions or warranties and Oxford University Innovation makes no representation and gives no warranty that it is the owner of the intellectual property rights in the technology described. 55

# Version 2 of the UKPDS OM - A type 2 diabetes outcomes model



Available to license: Substantially enhanced Type 2 diabetes simulation for use by epidemiologists, health economists and trialists for the evaluation and cost-effective analyses of strategies for diabetes management.

Oxford researchers have made a significant update to their computerised simulation tool designed to estimate life expectancy, quality adjusted life expectancy and the cumulative costs of complications in people with T2D.

## Why model type 2 diabetes?

Type 2 diabetes (T2D) is estimated to affect 9% of adults and cost \$465 billion each year. With these figures predicted to rise by 50% over the next 20 years, the provision of T2D care represents a major economic challenge for the healthcare industry. Given the extended timeframe and multiple outcomes associated with T2D, stakeholders frequently make use of health economic models to support evidence-based decision making related to funding allocation.

## The new and improved UKPDS OM2

The UKPDS OM is a computerised simulation tool designed to estimate Life Expectancy, Quality Adjusted Life Expectancy and the cumulative costs of complications in people with T2D. The newly released Version 2 represents a significant advance, making use of data from all 5,102 UKPDS patients who entered the trial and 4,031 survivors who entered the 10 year post-trial monitoring period. This equates to 89,760 patient-years of data and provides double the number of events compared with Version 1.

## Key new features

- Additional risk factors: Albuminuria, Heart rate, WBC, Haemoglobin and eGFR
- Additional clinical events: Diabetic ulcer and CVD death
- New equations predict second events for MI, Stroke and amputation
- Supports up to 3 groups of patients in a single run and provides a summary for each group as well as group differences
- Cost / utility values can now be varied by age and sex

- Addition of therapy costs and pre and post complication costs
- Calculation of Monte Carlo Error allows simulation fine-tuning
- Can queue workbooks to run multiple unattended simulations, while parallel processing can take full advantage of up to 10 computer cores.

## Tried and trusted

The UKPDS OM has been adopted by a range of companies, government bodies and Universities.

## Key Adopters:

- 4 out of the 5 largest diabetes drug manufacturers
- The UK National Institute of Health and Care Excellence (NICE)
- A wide range of healthcare consultancies

## Transparency and Flexibility

The UKPDS OM2 takes a completely transparent approach in which we fully report its development, including the equations that determine all outcomes, and the algorithm used to bring the elements of the model together.

The model uses Microsoft Excel workbooks and can operate on Windows and Mac OS X platforms.

**For further information please contact:**

**Dr James Groves**

[james.groves@innovation.ox.ac.uk](mailto:james.groves@innovation.ox.ac.uk)

+44 (0)1865 614425

[www.innovation.ox.ac.uk](http://www.innovation.ox.ac.uk)

Project number: 9965

## Technology Transfer from the University of Oxford

The information in this Project Profile is provided "as is" without conditions or warranties and Oxford University Innovation makes no representation and gives no warranty that it is the owner of the intellectual property rights in the technology described.

# iHOMA2 - Software for diabetes trials and research



Available to license: An interactive, 23-variable, H<sub>O</sub>meostatic Model of Assessment software package for diabetes trials and research.

iHOMA2 allows users to examine and modify the mathematical functions that describe the glucose and hormonal levels of a patient's organs and tissues.

## Diabetes

Type 2 diabetes is caused by a combination of progressive  $\beta$ -cell dysfunction, relative insulin deficiency, and variable degrees of insulin resistance that lead to dysregulation of glucose homeostasis. Understanding the biochemistry, phenotypic details, and genetic mechanisms contributing to this can yield important information on pathophysiology. The progressive nature of the disease, as well as measuring the rate of deterioration, has presented an ongoing challenge to clinicians and scientists alike.

## Oxford technology

iHOMA2 is an extension of the HOMA and HOMA2 mathematical models which were developed in Oxford from the mid-1980's. iHOMA2 is a software package which enables a user to examine and assess insulin resistance and  $\beta$ -cell functions in the fasting state. The input into the software package can either be fasting insulin and glucose values or percent  $\beta$ -cell function and percent insulin resistance - representing functional insulin secretion capacity and functional activity of insulin, respectively.

iHOMA2 can be used in:

- default mode - for comparison with all published data using HOMA and HOMA2,
- analytic mode - allows  $\beta$ -cell function and insulin sensitivity to be calculated from fasting insulin and glucose values,
- predictive mode - allows fasting insulin and glucose levels to be calculated from  $\beta$ -cell function and insulin sensitivity.

## Advantages

iHOMA2 models 23 interactive variables, representing multiple organs and tissues, which:

- allows descriptions of different states of type 2 diabetes to be modelled,
- allows effect of therapeutic agents to be simulated - whether the agent is used alone or in combination with other diabetes treatments,
- can be used for epidemiological analyses of populations where fasting insulin and glucose values are known.



**For further information please contact:**  
**Dr James Groves**  
[james.groves@innovation.ox.ac.uk](mailto:james.groves@innovation.ox.ac.uk)  
**+44 (0)1865 614425**  
[www.innovation.ox.ac.uk](http://www.innovation.ox.ac.uk)  
**Project number: 10766**

## Technology Transfer from the University of Oxford

The information in this Project Profile is provided "as is" without conditions or warranties and Oxford University Innovation makes no representation and gives no warranty that it is the owner of the intellectual property rights in the technology described.

# Early gestational diabetes diagnostic



Scientists at the University of Oxford have developed a test where circulating biomarkers from the placenta give an early indication of mothers who either are already presenting with gestational diabetes or are highly likely to develop the disease.

Gestational diabetes occurs when a woman becomes resistant to the effects of insulin during pregnancy and isn't able to make enough to overcome the resistance. It usually becomes evident in the second or third trimester.

Gestational diabetes can cause complications for both mother and baby during and after birth. These include the baby growing larger than usual, which may lead to difficulties during the delivery and increases the likelihood of needing induced labour or a caesarean section, and increased risk of premature birth and stillbirth. However, the risk of complications can be reduced if the disease is detected early enough and well managed.

## Complications of gestational diabetes

Currently, there is no method of determining whether a pregnant woman is likely to develop gestational diabetes. The only diagnostic test is an oral glucose tolerance test (OGTT), which is done late on in gestation, at around 24-28 weeks, and is dependent upon the patient already has the disease. Moreover, the OGTT is not a particularly effective test, in part because of lack of compliance by patients who are required to fast before having the test.

Scientists at the University of Oxford have developed a test where circulating biomarkers from the placenta give an early indication of mothers who either are already presenting with gestational diabetes or are highly likely to develop the disease. Early diagnosis is key to managing the condition well and reducing complications arising from the disease.

If gestational diabetes is not detected and left untreated, it can increase the risk of serious birth complications for both mother and baby. These include macrosomia (large babies), premature birth,

miscarriage and stillbirth. In addition to the increased risk of complications associated with gestation and delivery, there are also serious post-natal complications associated with gestational diabetes, for example, there is an increased risk that both mother and baby will develop type 2 diabetes later in life.

Around 35,000 women are diagnosed with gestational diabetes in the UK alone with the global gestational diabetes market expected to grow at a CAGR of 5.4% up to 2023.

The increase in the obese population and lifestyle factors are driving the growth of the market. Not only can this invention be used to diagnose gestational diabetes early, it can predict whether a subject is likely to develop gestational diabetes and subsequently clinicians can better advise on the prognosis.



**For further information please contact:**  
**Dr Dinali de Silva**  
[dinali.desilva@innovation.ox.ac.uk](mailto:dinali.desilva@innovation.ox.ac.uk)  
**+44 (0)1865 614441**  
[www.innovation.ox.ac.uk](http://www.innovation.ox.ac.uk)  
**Project number: 10804**

## Technology Transfer from the University of Oxford

The information in this Project Profile is provided "as is" without conditions or warranties and Oxford University Innovation makes no representation and gives no warranty that it is the owner of the intellectual property rights in the technology described.

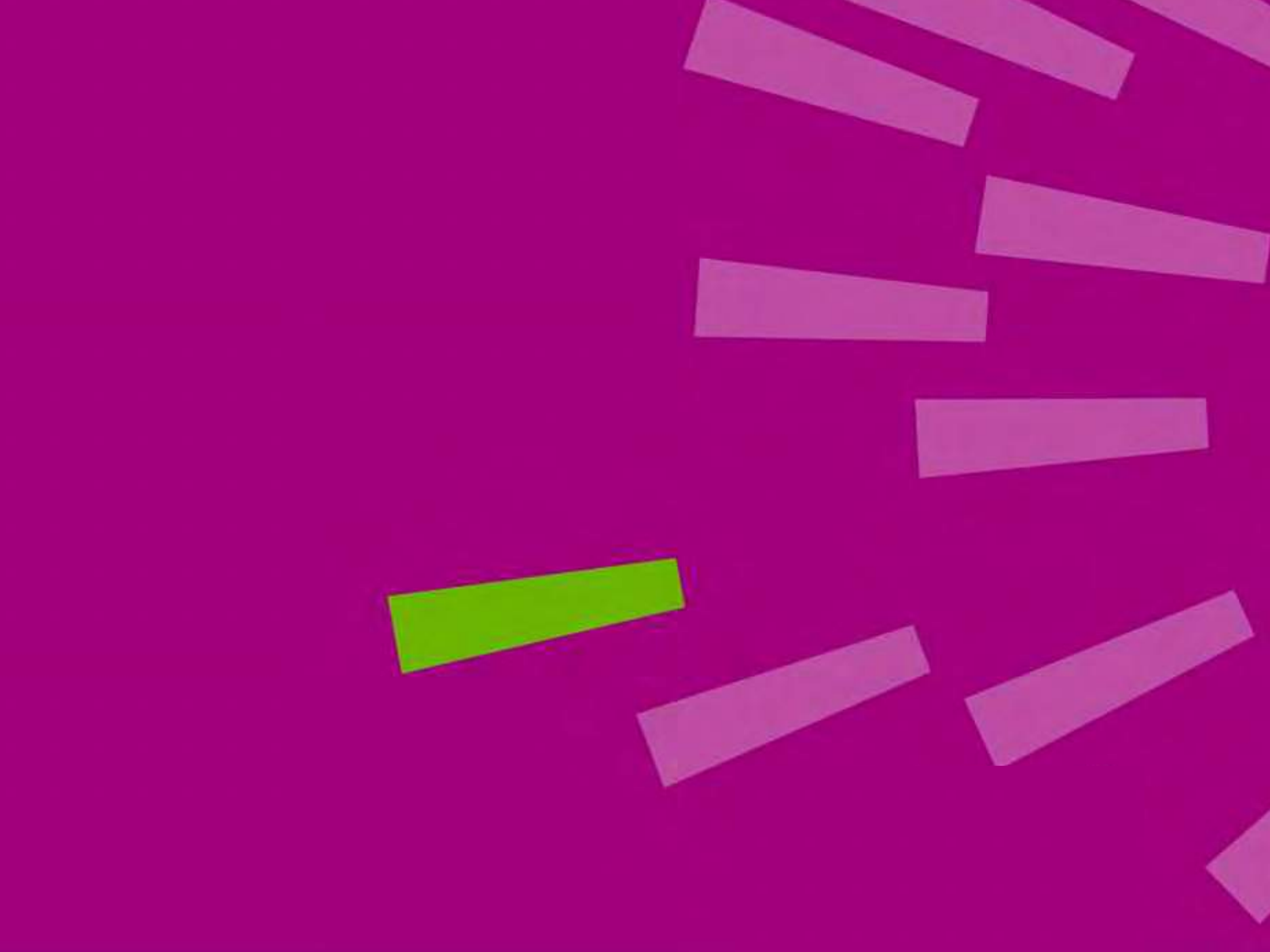

# NEUROSCIENCE

# Are you awake?



**Available to license:** Method for measuring consciousness and depth of anaesthesia.

## A personalised approach to preventing awareness during surgery

When an individual undergoes general anaesthesia their level of consciousness is estimated from a variety of indirect measures such as heart rate, blood pressure and respiration. While the risk of an anaesthetic overdose is low, and the chance of waking up during surgery lower still, a direct and accurate measure of patient awareness would be highly beneficial in terms of both patient experience and reducing anaesthetic-related morbidity.

## A new brain signature for unconsciousness

Using complementary brain imaging methods researchers have identified a 'slow-wave saturation' signature that may be used to develop a platform for pinpointing sufficient loss of awareness and optimal anaesthetic dose.

- EEG slow-waves increase as a patient is anaesthetised and hit a saturation point following a loss of awareness, despite further dosing
- Point of saturation corresponds with fMRI data showing functional isolation of the brain from external stimuli
- Signature is personalised, correlating with an individual's grey matter volume
- EEG signature could provide a direct indicator of a patient's awareness and regulate the anaesthetic dose accordingly

## A foundation for superior anaesthetic monitoring

The slow-wave saturation signature identified in this study provides a platform on which to develop a superior and rationale-driven system for monitoring

consciousness during surgical and intensive care anesthesia. We envisage that this discovery will be of interest to companies wishing to either integrate advanced technology into their existing patient monitoring systems or those looking to capitalise on this research through the development of a stand-alone monitor based on slow-wave neuronal oscillations.

## Patent protection

A patent application covering the use of slow-wave oscillations to monitor consciousness is currently in PCT phase (PCT/GB2013/051445). Isis Innovation would like to speak to companies interested in developing this method.

*"Despite hundreds of thousands of anaesthetics administered daily to patients, remarkably there is no robust, individualised indicator of perceptual awareness available"* - Professor Irene Tracey, Director of FMRIB at the University of Oxford



**For further information please contact:**

**Dr Paul Ashley**

**paul.ashley@innovation.ox.ac.uk**

**+44 (0)1865 280845**

**www.innovation.ox.ac.uk**

**Project number: 8818**

## Technology Transfer from the University of Oxford

The information in this Project Profile is provided "as is" without conditions or warranties and Oxford University Innovation makes no representation and gives no warranty that it is the owner of the intellectual property rights in the technology described.

# Diagnosing neurological autoimmune disease



**Available to license:** Autoantibodies against a subunit of the GABAA receptor are involved in neurological and psychiatric disease and represent a new biomarker for the diagnosis of autoimmune disease.

Led by Professor Angela Vincent, Oxford scientists have identified the presence of autoantibodies that target the  $\gamma 2$  subunits of the GABA<sub>A</sub> receptor.

## Protection turned on oneself

Our immune system provides a critical defence against foreign and potentially harmful invaders. However, autoimmunity is a misguided response where renegade immune cells are unable to differentiate self from non-self, resulting in the destruction of the body's own cells.

Autoimmune disorders affect 5-10% of the population and often involve antibodies against proteins of the central nervous system. This can result in a number of neurologic disorders, including encephalopathies, and subgroups of epilepsies and psychiatric disease. However, once the specific antibodies have been identified, prompt diagnosis and therapy can occur.

## Revealing a target of GABA autoimmunity

The GABA<sub>A</sub> receptor is the principle mediator of inhibitory synaptic transmission in the human brain and is the target for many therapeutic drugs, such as treatments for anxiety, insomnia and epilepsy.

By retrospectively analysing the sera of patients suffering from a range of neurological and psychiatric symptoms, researchers from the University of Oxford have identified the  $\alpha 1$  and  $\gamma 2$  subunits of the GABA<sub>A</sub> receptor as a target of autoimmunity (published in the journal *Neurology*, Pettingill et al., 2015). Patients who expressed antibodies for  $\alpha 1$  and  $\gamma 2$  subunits exhibited a range of disorders, including seizures, memory impairments, anxiety and psychosis. Furthermore, when the antibody-containing serum from these patients was washed over neuronal cultures, it resulted in a specific down-regulation of  $\alpha 1$  and  $\gamma 2$  subunit expression, indicative of a causative effect.

It was also found that immunotherapy was beneficial in this group of  $\alpha 1/\gamma 2$  autoimmune patients, with one boy suffering from severe catatonia twice exhibiting substantial immunotherapy-mediated improvement that correlated with normalization of his GABA<sub>A</sub> antibody levels.

## A tool for diagnosis and therapy

Autoimmune channelopathies may have a good prognosis, especially if diagnosed and treated early. This discovery provides the rationale for improving diagnosis and prognosis for this newly identified GABA<sub>A</sub>  $\alpha 1$  and  $\gamma 2$  variant of central nervous system autoimmune disease.

Oxford University Innovation has filed an international patent application PCT/GB2015/051388 (12th May 2015) and would welcome discussions with companies engaged in autoimmunity research and those interested in incorporating this discovery into their antibody screening technology.

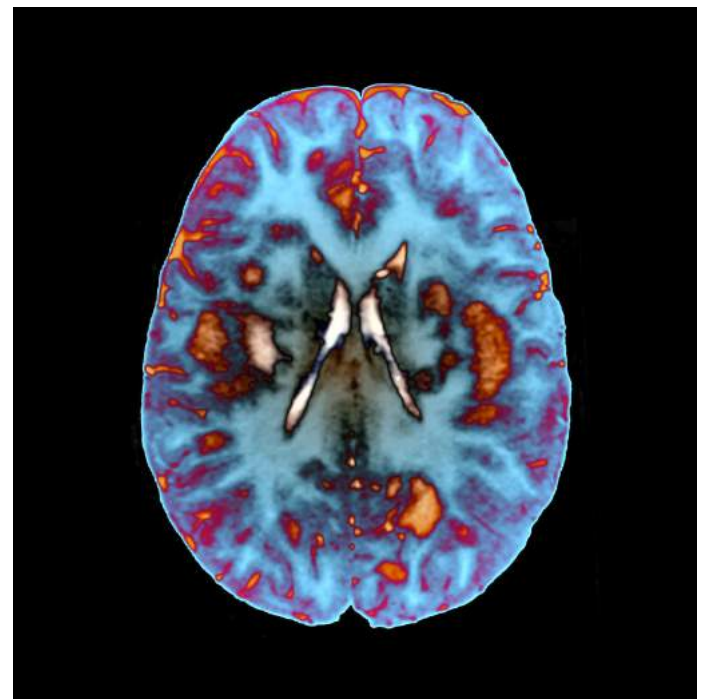

**For further information please contact:**

**Benedicte Menn**

[benedicte.menn@innovation.ox.ac.uk](mailto:benedicte.menn@innovation.ox.ac.uk)

+44 (0)1865 280906

[www.innovation.ox.ac.uk](http://www.innovation.ox.ac.uk)

**Project number: 11128**

## Technology Transfer from the University of Oxford

The information in this Project Profile is provided "as is" without conditions or warranties and Oxford University Innovation makes no representation and gives no warranty that it is the owner of the intellectual property rights in the technology described.



# Targeted drug delivery to the brain for treating neurodegenerative diseases



Researchers at the University of Oxford have developed novel drug delivery vehicles capable of directly targeting areas of the brain affected by abnormal tau aggregation, in diseases such as Alzheimer's disease.

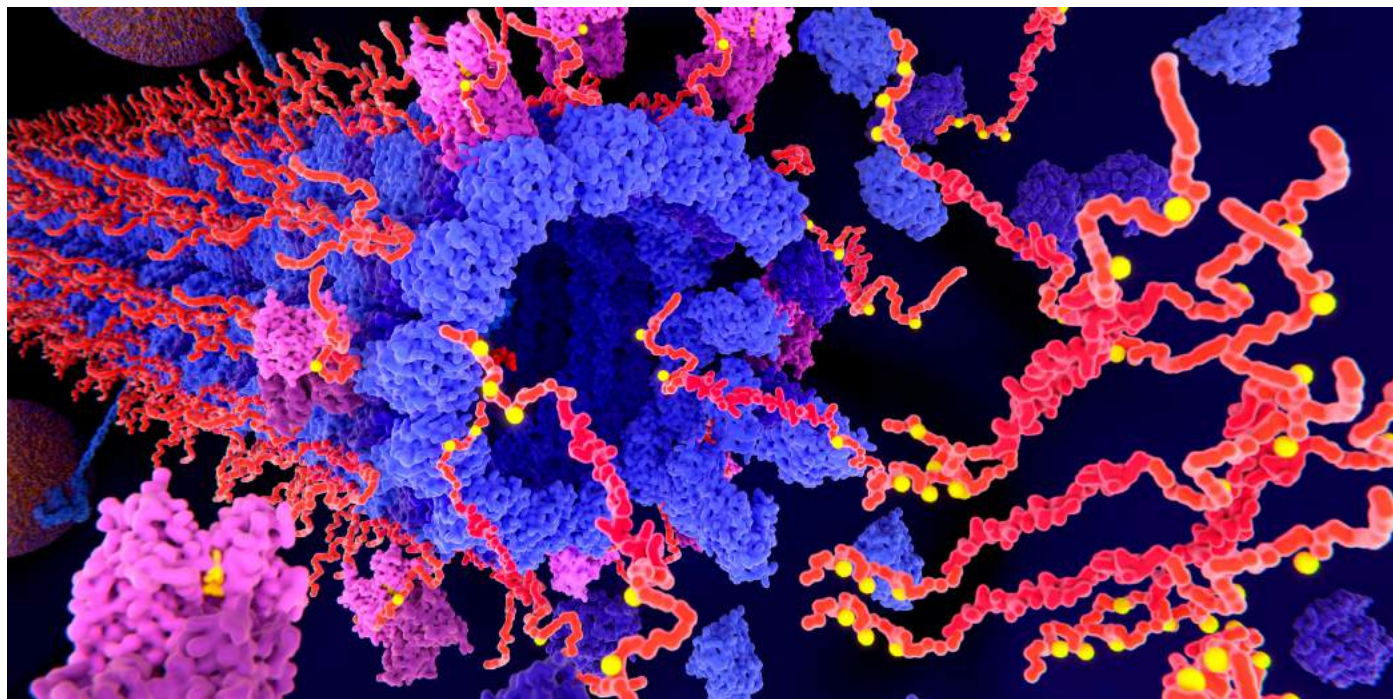

## Brain targeting of small molecules

Drug targeting to the brain is a major challenge due to the presence of the blood brain barrier which exists between the central nervous system and peripheral circulation. The highly selective and tightly regulated, restricting passage of molecules make it difficult for therapeutics to reach their active site within the brain.

Tau proteins are large sized molecules that stabilize microtubules within cells and are abundant in the central nervous system. Microtubules provide structure to the cell, and so abnormal tau proteins cause toxic effects by aggregating and forming structures known as neurofibrillary tangles that cause microtubule breakdown, cell death and the subsequent cognitive decline seen in Alzheimer's disease, frontotemporal dementia and other tauopathies.

## Lipid-mediated transport

Researchers at the University of Oxford have developed a drug delivery vehicle for selectively delivering active agents to affected areas of the brain. It consists of a liposome, a spherical lipid vesicle containing the active agents, conjugated to a targeting agent such as a Lewis antigen.

The targeting agent specifically targets cell-adhesion molecules such as selectins, which are frequently transported across the blood brain barrier and into microglial cells within the brain.

Consequently, the targeting of these molecules enables delivery of drug payload to sites of interest in areas of otherwise inaccessible brain pathology.

## Commercialisation

Oxford University Innovation are seeking partners to license this innovative technology and support its continued development. A patent application has been filed to cover this method.

For further information please contact:

Iraida Soria Espinosa

[iraida.soriaespinosa@innovation.ox.ac.uk](mailto:iraida.soriaespinosa@innovation.ox.ac.uk)

+44 (0)1865 614453

[www.innovation.ox.ac.uk](http://www.innovation.ox.ac.uk)

Project number: 15744

## Technology Transfer from the University of Oxford

The information in this Project Profile is provided "as is" without conditions or warranties and Oxford University Innovation makes no representation and gives no warranty that it is the owner of the intellectual property rights in the technology described.



ONCOLOGY

# Acute myeloid leukaemia prognostic and diagnostic screening



Oxford researchers, in collaboration with the University of Birmingham, have discovered novel combinations of cell-surface biomarkers (CD molecules) that allow acute myeloid leukaemia to be stratified into 3 different molecular sub-types to allow targeted treatment and better monitoring of treatment response.

Acute Myeloid Leukaemia (AML) is a type of aggressive blood cancer, with several molecular sub-types. Current treatments aim to reduce (to less than 5% of the original amount) levels of leukemic stem cells (LSC), which are thought to be responsible for sustaining the disease and leading to relapse.

However, until now, no technologies were available that could determine the molecular sub-type of AML present in the patient (to predict disease course and inform treatment with targeted therapeutics) and detect and monitor the levels of these remaining LSCs.

Driven by this unmet need, researchers at the University of Oxford have discovered combinations of cell-surface biomarkers which are capable of meeting both objectives.

## Advantages of the biomarkers

- Improved sensitivity in AML diagnosis and prognosis
- Patient stratification, saving time and money by avoiding inappropriate treatments and improving patient wellbeing
- Assessment of treatment efficacy

## Current challenges in AML therapy

The goal of AML therapy is to reduce the amount of bone marrow leukaemic cells to less than 5%. However, despite this level of reduction, most patients relapse without post-induction chemotherapy or a haematopoietic stem cell transplant. These procedures aim to eliminate minimal residual disease: leukaemic cells that resist therapy. Leukaemic stem cells (LSC) are thought to be responsible for sustaining disease.

The advantage of the Oxford biomarkers is that they follow LSC populations directly and hence provide a novel strategy for following disease progression.

The new biomarkers detect LSC at lower levels than was previously possible.

Recent studies have also demonstrated that AML consists of a group of diseases, and this technology allows stratification of patients by disease sub-type, allowing the most appropriate treatment to be selected, potentially improving treatment efficacy.

## AML facts

- Aggressive cancer of the myeloid line of white blood cells
- The most common adult acute leukaemia, affecting over 15,300 people a year in the US and UK combined
- More common in adults aged over 65, with only 5% overall survival in this patient group
- Prevalence is expected to increase as the population ages

## Supporting data

Clinical and in vivo proof-of-concept data showing that the biomarker combinations identify LSCs:

Goardon N et al (2011). *Cancer Cell*. 19(1):138-52

Quek L et al (2016). *J Exp Med*. Jul 25;213(8):1513-35

## Patent position

This technology is subject to a family of international patent applications including use and method claims for biomarkers for AML. Oxford University Innovation would like to hear from companies who wish to license this technology for further development.

**For further information please contact:**

**Dr Richard Reschen**

**[richard.reschen@innovation.ox.ac.uk](mailto:richard.reschen@innovation.ox.ac.uk)**

**+44 (0)1865 280872**

**[www.innovation.ox.ac.uk](http://www.innovation.ox.ac.uk)**

**Project number: 4130, 11532**

## Technology Transfer from the University of Oxford

The information in this Project Profile is provided "as is" without conditions or warranties and Oxford University Innovation makes no representation and gives no warranty that it is the owner of the intellectual property rights in the technology described.

# Brain tumour detection and treatment



Oxford University researchers have developed a method to selectively increase permeability of the blood-brain barrier at sites of secondary brain tumours.

## Brain Cancer

Brain metastasis (BM) is one of the greatest hurdles in cancer therapy; 20-40% of all cancer patients will suffer metastatic spread of the primary cancer to the brain. Unfortunately, our inability to diagnose BM early enough and to obtain an accurate measure of the number of metastases present is a major limitation in the treatment and management of cancer patients. Clinical diagnosis of BM is limited to larger, late-stage metastases (>5mm) and early detection (<5mm) remains impossible.

## Diagnosis and treatment

The presence of the blood-brain barrier is the primary reason why diagnosis and treatment of BM is so problematic, as it has specifically evolved to restrict the diffusion of many molecules into the brain.

## Oxford Invention

Using cytokine-enhanced Magnetic Resonance Imaging (MRI), detection of BM of the order of 100µm in diameter in preclinical models has been achieved. Translation of these findings into the clinical setting would equate to diagnosis several months earlier than conventional gadolinium-based MRI. Importantly, this approach would facilitate specific delivery of potential tumour chemotherapies and radiosensitisers to these early stage tumours, to enhance and extend current treatment options.

## Supporting Data

The work at the University of Oxford has demonstrated:

- Low dose cytokines can be used to temporarily and reversibly increase blood-brain barrier permeability

and, thus, improve delivery of imaging agents and anti-cancer drugs.

- Cytokines only induce breakdown of the blood-brain barrier breakdown at tumour sites to enable these sites to be imaged by MRI with contrast agents that are normally excluded from the brain.

## Patent Position

The patent application (WO2011/070358 'systemic administration of an agent that permeabilises tumour vasculature') covering the invention was published in June 2011.



Secondary brain cancer, MRI scan

For further information please contact:  
**Dr Sarah Deakin**  
[sarah.deakin@innovation.ox.ac.uk](mailto:sarah.deakin@innovation.ox.ac.uk)  
**+44 (0)1865 614410**  
[www.innovation.ox.ac.uk](http://www.innovation.ox.ac.uk)  
**Project number: 6855**

## Technology Transfer from the University of Oxford

The information in this Project Profile is provided "as is" without conditions or warranties and Oxford University Innovation makes no representation and gives no warranty that it is the owner of the intellectual property rights in the technology described.

# New lead compounds for treating cancers involving Ras mutations



Oxford University researchers have developed small molecule inhibitors of Ras proteins, important therapeutic targets in a large number of cancers.



Cancer is a major global disease burden, costing the NHS approximately £5bn a year. Around 97% of pancreatic cancer and 45% of colorectal cancer are the result of Ras family gene mutations, and a number of other cancers are linked to Ras mutations, making it a key drug target for cancer therapy.

## Methods for treating cancer

Attempts to develop drugs that target mutant Ras have so far been unsuccessful, meaning tumours bearing this mutation remain the hardest to treat. Small molecules are able to readily penetrate cells, however, were not initially thought to be able to interfere with protein-protein interactions.

Such small molecules have been discovered by identifying antibody fragments capable of binding to Ras and using their structure to derive smaller compounds that mimic their properties. The antibody fragments are therapeutically ineffective without intracellular delivery, as they are unable to penetrate the cell membrane to reach their targets.

## Development of Ras inhibitors

Researchers from the University of Oxford have found numerous small molecule Ras inhibitors, the most potent of which has been shown to effectively block protein-protein interactions between Ras and effector molecules in cell-based assays.

These unique small molecules offer a potential therapy for those suffering from mutated Ras related cancers where there is currently no treatment available.

**For further information please contact:**  
**Dr Matthew Carpenter**  
[matthew.carpenter@innovation.ox.ac.uk](mailto:matthew.carpenter@innovation.ox.ac.uk)  
**+44 (0)1865 280970**  
[www.innovation.ox.ac.uk](http://www.innovation.ox.ac.uk)  
**Project number: 8636**

## Technology Transfer from the University of Oxford

The information in this Project Profile is provided "as is" without conditions or warranties and Oxford University Innovation makes no representation and gives no warranty that it is the owner of the intellectual property rights in the technology described.

# Novel cancer treatment to improve the efficiency of radiotherapeutic methods



Oxford researchers have developed a new method to treat cancer by increasing the efficiency of radiotherapeutic techniques such as proton beam therapy and x-ray radiation.



A number of different techniques may be used in the management and treatment of cancers. These include chemotherapeutic methods, radiotherapeutic methods, photodynamic therapy, surgical methods, hormonal therapy and embolisation. Embolisation, in particular, is a non-surgical, minimally invasive procedure in which blood vessels are selectively occluded by introducing emboli. In cancer treatments, embolic particles can be introduced into the blood stream close to the target and lodge in the small vessels which feed the tumour restricting blood flow. As a result, oxygen and nutrient supplies to the tumour are reduced which causes tumour necrosis.

Radiotherapeutic methods and photodynamic therapy are also effective in reducing tumour size. Photodynamic therapy (PDT) is commonly used to treat some types of cancer. PDT involves injecting a photosensitizing agent into the bloodstream of a patient. The agent is absorbed by cells all over the body, but it generally accumulates in the tumour due to abnormalities or defects in the tumour vasculature.

It is also rapidly absorbed by cancer cells, which tend to grow and divide much more quickly than healthy cells and hence have a higher metabolic activity.

Cancers may also be treated using radiotherapy, which involves the use of ionising radiation, such as x-rays or proton beam radiation. Radiation therapy most commonly uses x-rays but protons or other forms of energy can also be used. Proton beam therapy is a type of radiotherapy that uses a beam of high energy protons rather than x-rays to treat specific types of cancer.

Scientists at Oxford have developed a method of improving the efficacy of cancer treatment by developing a range of embolisation particles to be used in conjunction with x-ray or proton beam radiation.

**For further information please contact:**  
**Dr Dinali de Silva**  
[dinali.desilva@innovation.ox.ac.uk](mailto:dinali.desilva@innovation.ox.ac.uk)  
**+44 (0)1865 614441**  
[www.innovation.ox.ac.uk](http://www.innovation.ox.ac.uk)  
**Project number: 9086**

## Technology Transfer from the University of Oxford

The information in this Project Profile is provided "as is" without conditions or warranties and Oxford University Innovation makes no representation and gives no warranty that it is the owner of the intellectual property rights in the technology described.

# Prediction method for skin cancer development risk in renal transplant recipients



Academics at the University of Oxford have developed a method to detect RTRs at risk of developing SCC, by quantifying the proportion of CD8 T-cells that express CD57 on their surface.

Each year in the UK, almost 3,000 adults receive a renal transplant. Within 20 years, 30-40% will develop cutaneous squamous cell carcinoma (SCC), the second most common type of skin cancer. A major contributor to the development of SCC is the life-long immunosuppression given to renal transplant recipients (RTR) to reduce the risk of transplant rejection by the immune system. Some RTR may be taking more immunosuppression than required, particularly patients at high risk of developing SCC.

## Predicting at-risk patient groups

Researchers at the University of Oxford have developed a method to determine RTRs who are at increased risk of developing SCC and SCC recurrence, using flow cytometry. The team's recently published results in JASN (<http://jasn.asnjournals.org/content/27/5/1505.full>) show that by analysing the proportion of certain T-cells that express the CD57 antigen, patients can be grouped into those at higher and lower risk of developing subsequent SCC, before it develops. This represents one of the strongest markers of subsequent SCC development identified and is independent of previously identified clinical risk markers.

## Potential proactive patient monitoring

In a clinical setting, this method could be used in routine renal transplant follow-up. A patient's T-cells could be phenotyped to determine the best clinical pathway depending on the result.

For high-risk patients, this may allow for the pre-emptive reduction of drug-based immunosuppression with increased confidence that a patient is less likely to

develop transplant rejection. This proactive approach may also reduce the incidence of malignancy in the long term. It could allow low-risk patients to attend fewer follow-up dermatology appointments, saving both time and considerable consultation costs, whilst high-risk RTRs could have more frequent monitoring from a healthcare professional.

The stratification method may also be potentially useful in other organ transplant populations to identify those at increased risk of SCC and to guide immunosuppression intensity.

This technology is subject to a PCT patent application (PCT/GB2015/053176) and is available to license. Oxford University Innovation would like to speak to parties interested in developing this technology.



**For further information please contact:**

Dr S #  
s . @innovation.ox.ac.uk  
+44 (0)1865 614410  
www.innovation.ox.ac.uk  
Project number: 11735

## Technology Transfer from the University of Oxford

The information in this Project Profile is provided "as is" without conditions or warranties and Oxford University Innovation makes no representation and gives no warranty that it is the owner of the intellectual property rights in the technology described.

# Stratification method for proximal colorectal cancer patients



**Available to license:** A method for stratifying colorectal cancer patients based on the location and biomarker profile of the tumour.

Oxford researchers have developed a process for classifying CRC tumours allowing for the administration of more targeted therapies, leading to more positive patient outcomes.

## Colorectal Cancer

Colorectal cancer (CRC) is widespread in the UK with roughly 40,700 people being diagnosed with CRC in 2010. This is equivalent to more than 110 people every day. Around 1 in 20 people will develop CRC in their lifetime. Treatment of CRC generally involves a combination of surgery and chemotherapy; however, it has been found that some tumours respond poorly to widely used chemotherapeutic agents.

## Personalised Medicine

In patients with CRC the location and genetic profile of the tumour drastically affects their prognosis. Accurate characterisation of these tumours through biomarker analysis allows for the administration of more personalised therapies. For this to be possible, new methods are required to differentiate these CRC subtypes.

## Molecular Stratification

Oxford researchers have identified a proximal, IL22RA1<sup>high</sup>, KRAS mutant molecular CRC subtype. The presence of these biomarkers dramatically worsens the prognosis for patients with proximal CRC. In KRAS mutant tumours, IL-22 promotes both chemoresistance and clonogenic outgrowth. Due to this, the group proposes an alternative CRC treatment based on anti-IL-22 monoclonal antibody therapy.

The benefits of this molecular stratification include:

- Identification of CRC subtype with poor prognosis
- Allows adaptation of the treatment administered
- New avenues for treatment of the CRC subtype

This stratification method provides insight into a subtype of CRC potentially allowing for more effective treatment for patients with proximal CRC. This approach may also be applied to other cancer types.

## Commercialisation

This technology is subject to a patent application. Oxford University Innovation would like to speak to companies interested in licensing and developing this technology.

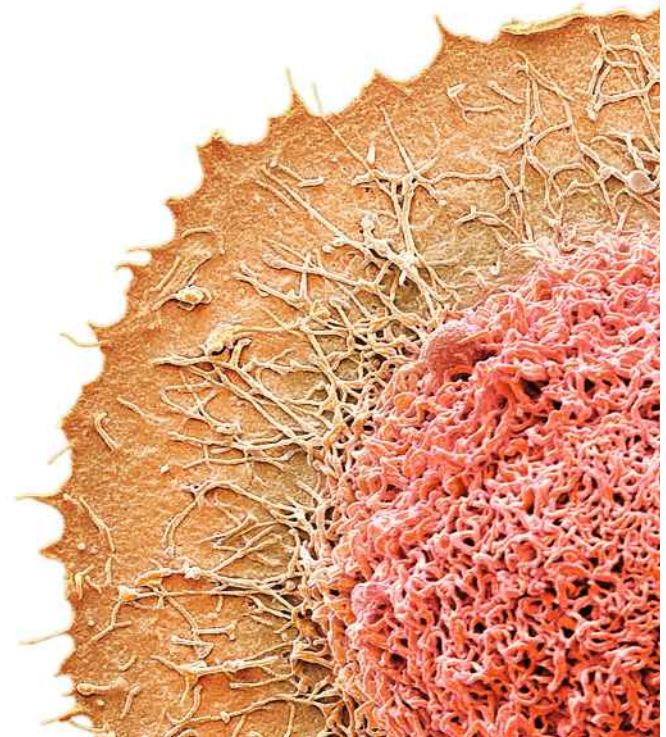

**For further information please contact:**  
**Dr Matthew Carpenter**  
[matthew.carpenter@innovation.ox.ac.uk](mailto:matthew.carpenter@innovation.ox.ac.uk)  
**+44 (0)1865 280970**  
[www.innovation.ox.ac.uk](http://www.innovation.ox.ac.uk)  
**Project number: 12273**

## Technology Transfer from the University of Oxford

The information in this Project Profile is provided "as is" without conditions or warranties and Oxford University Innovation makes no representation and gives no warranty that it is the owner of the intellectual property rights in the technology described.



# IGF2-TRAP: High affinity receptors to sequester growth factors linked to cancer



Researchers at the University of Oxford have identified key mutations that increase the affinity of Insulin-like Growth Factor 2 Receptor (IGF2R) for its ligand, reducing hypoglycaemia and tumour volume.

Insulin-like growth factors (IGF) are overexpressed in cancer cells and reductions in their expression are associated with tumour reduction. Previous efforts to inhibit IGF signalling by focussing on the IGF1 receptor have so far been unsuccessful.

Researchers at the University of Oxford have investigated the IGF2 receptor (IGF2R) and have identified mutations in domain 11 of IGF2R that increase the affinity of IGF2 to its receptor. These mutated receptors have been shown to treat hypoglycaemia and reduce tumour volume.

Insulin-like Growth Factor 2 (IGF2) encodes a member of the insulin family of polypeptide growth factors, which are involved in development and growth. Overexpression of this growth factor gene has been reported in a wide range of cancers and is associated with an increased risk of developing early childhood tumours.

IGF2 activates MAPK and PI3K pathways by binding to the ubiquitously expressed IGF1 receptor (IGF1R) and isoform A of the Insulin Receptor (IR-A). Unlike IGF1R, which is responsible for active signalling, IGF2R acts as an IGF2 sink to prevent excess IGF2 signalling.

Ligand bioavailability in cancer is often increased due to increased IGF2 expression, proteolytic cleavage of inhibitory proteins and loss of function of the sink receptor IGF2R. IGF2 is thought to be a major driver of resistance to several therapies, including anti-HER2, anti-EGFR and anti-Androgen in breast, colorectal, prostate and lung cancers.

Inhibition of IGF signalling has been an area of major focus by pharma, with many failures due to either receptor redundancy (between IGF1R and IR-A) or the IGF1 feedback loop. This causes the pituitary gland to produce more growth hormone, instructing the liver to produce more IGF1, generating a potential dose limiting toxicity of hyperglycaemia.

Tumours that cause hypoglycaemia overexpress IGF2 and secrete excessive amounts of partially processed

precursors of IGF2, named big-IGF2. This causes the rare condition of non-islet cell tumour hypoglycaemia (NICTH).

Researchers at the University of Oxford, along with their collaborators, have identified a number of key mutations in the IGF2R that increase affinity with IGF2. These mutated receptors act as traps for IGF2 (IGF2-TRAP), thus sequestering this overexpressed ligand. The mutated IGF2R have been tested *in vivo* – IGF2-induced hypoglycaemia in mice was abolished in the presence of the IGF2-TRAP, and a reduction in tumour volume was observed in Ewing sarcoma cells xenograft models treated with IGF2-TRAP.

The Oxford researchers have gone on to identify two PI3 kinase inhibitors that act synergistically with the IGF2-TRAP to reduce the dose requirements of these inhibitors and improve the long-term tumour-killing efficacy of IGF2-TRAP.

The IGF2R mutations are protected by a patent now granted in Europe and the USA, and another international patent application.

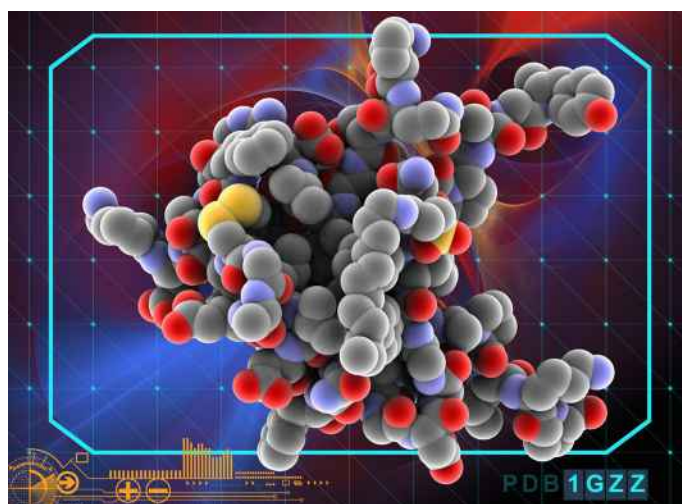

For further information please contact:

Dr Christine Whyte

[christine.whyte@innovation.ox.ac.uk](mailto:christine.whyte@innovation.ox.ac.uk)

+44 (0)1865 280921

[www.innovation.ox.ac.uk](http://www.innovation.ox.ac.uk)

Project number: 15455, 15456

## Technology Transfer from the University of Oxford

The information in this Project Profile is provided "as is" without conditions or warranties and Oxford University Innovation makes no representation and gives no warranty that it is the owner of the intellectual property rights in the technology described.

# Preclinical and clinical evaluation of forodesine in patients with leukaemia



Researchers at Oxford University have identified a specific use of the drug forodesine to treat chronic lymphocytic leukaemia in patients with a specific genetic mutation.

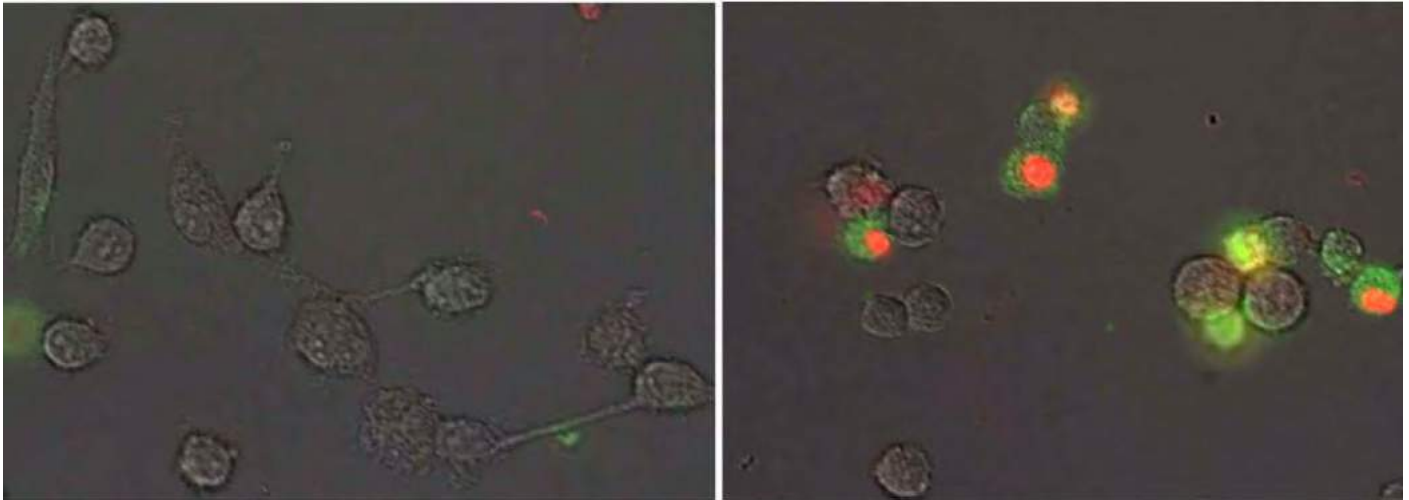

Chronic lymphocytic leukaemia (CLL) is a type of cancer that affects the white blood cells and tends to progress slowly over many years. In patients with CLL, the bone marrow makes too many lymphocytes. Symptoms include higher levels than unusual of bruising and bleeding, night sweats, high temperatures and swollen glands. It is one of the most common types of leukaemia in adults and usually occurs around or after middle age with about 90% of chronic lymphocytic leukaemia diagnosed in middle age.

The Incidence rate of CLL is higher in men and women over 50 years of age. It is rarely seen in people under age 40 and is extremely rare in children Over 3000 people are diagnosed with CLL every year in the UK alone and in 2016 there were over 18,000 new cases of CLL in the US.

The CLL market is expected to grow from \$7.7bn in 2017 to \$9.2bn by 2027 at a compound annual growth rate (CAGR) of 1.8%. Treatment for CLL largely depends on what stage the condition is at when it's diagnosed. The increasing elderly population worldwide is driving market growth and there is a strong need for more effective treatments.

## New treatment in CLL

Researchers at Oxford University have identified a specific use of the drug forodesine to treat CLL in patients with a specific genetic mutation.

Scientists have demonstrated greater efficacy of the drug in patients with CLL that have a specific genetic mutation compared to those who do not. It is expected that CLL patients with this mutation will have a higher response rate to the drug which will ultimately improve treatment efficacy and increase life expectancy.

For further information please contact:  
**Dr Dinali de Silva**  
[dinali.desilva@innovation.ox.ac.uk](mailto:dinali.desilva@innovation.ox.ac.uk)  
**+44 (0)1865 614441**  
[www.innovation.ox.ac.uk](http://www.innovation.ox.ac.uk)  
**Project number: 15790**

## Technology Transfer from the University of Oxford

The information in this Project Profile is provided "as is" without conditions or warranties and Oxford University Innovation makes no representation and gives no warranty that it is the owner of the intellectual property rights in the technology described.

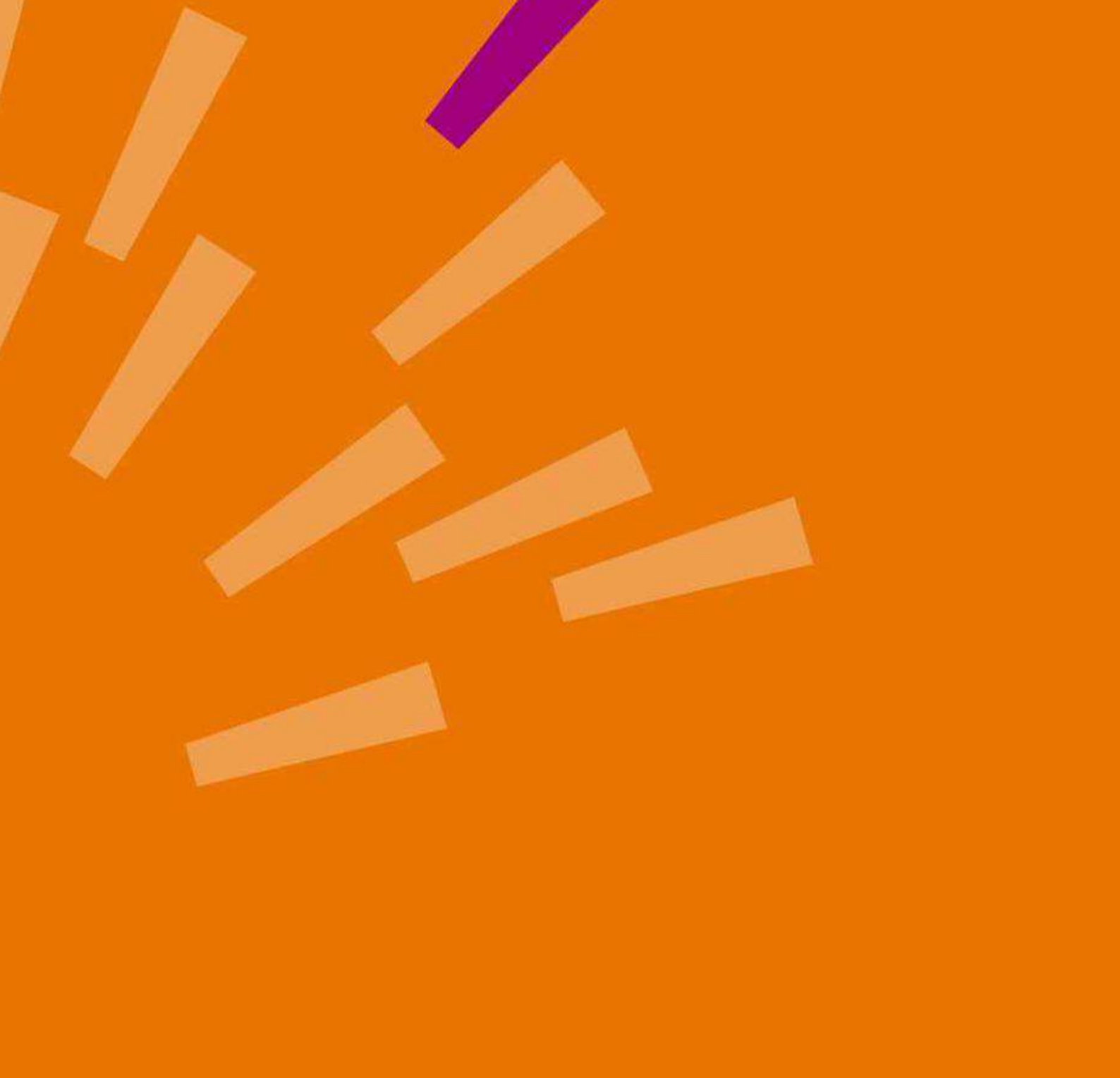

# ORTHOPAEDICS

# Degradable implant to enhance surgical repair of musculoskeletal tissue



Oxford researchers have developed a multi-layered degradable patch that enhances the surgical repair of musculoskeletal tissue with improved mechanical and biocompatible properties.

The musculoskeletal system provides form, support, stability and movement to the body. Over 50% of adults who live in the US suffer from musculoskeletal diseases and there are currently no adequate solutions to improve tendon healing after a surgical procedure. A major musculoskeletal system is the rotator cuff, a group of muscles and tendons that surround the shoulder joint. Over 50% of people over the age of 66 suffer from tears of the rotator cuff requiring surgery, on average over 40% of surgical reattachments of the rotator cuff fail. Current structures available are limited due to infection, biocompatibility and loss of integrity in the long-term.

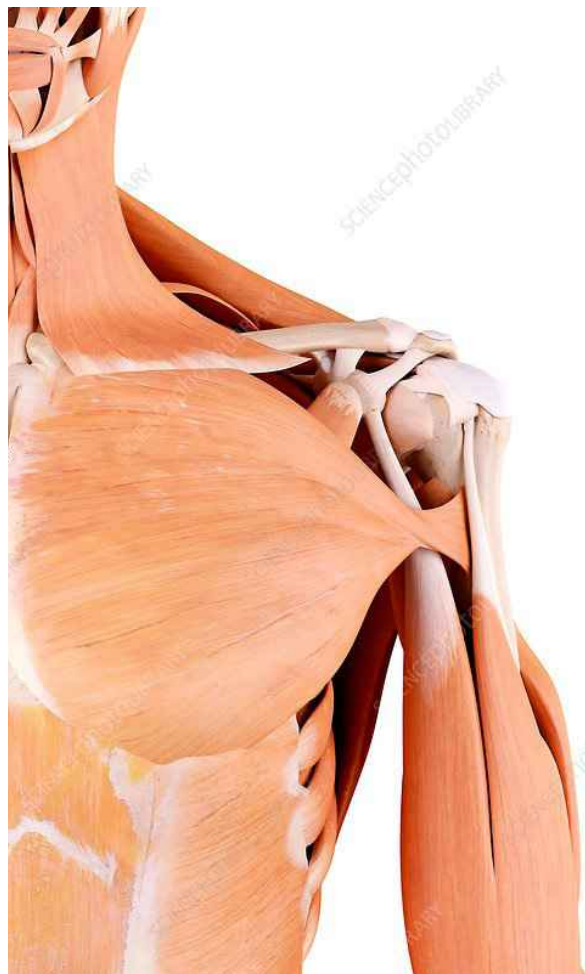

## Biocompatible scaffold materials

Oxford researchers have developed an enhanced absorbable and biocompatible implant which enhances the surgical repair of the musculoskeletal tissue. This patch provides a degradable synthetic scaffold.

Existing scaffolds have been able to minimise the risk of infection but are limited in terms of biocompatibility and/or mechanical properties. This invention is unique compared to existing scaffolds because of the innovative combination of non-woven and woven components in a multi-layered degradable patch.

## Tissue engineering

The woven component provides the mechanical properties whereas the non-woven electrospun component provides the compatibility by stimulating new tissue formation providing new tendon-like features to the cells. This novel way of layering tackles both mechanical and biological aspects of tissue repair.

This multi-layered implant has the potential to enhance the surgical repair of the rotator cuff and other musculoskeletal repairs but also has potential applications in other fields such as filtration, protective materials and the environment.

**For further information please contact:**

**Dr Angela Calvert**

**[angela.calvert@innovation.ox.ac.uk](mailto:angela.calvert@innovation.ox.ac.uk)**

**+44 (0)1865 280870**

**[www.innovation.ox.ac.uk](http://www.innovation.ox.ac.uk)**

**Project number: 8573**

## Technology Transfer from the University of Oxford

The information in this Project Profile is provided "as is" without conditions or warranties and Oxford University Innovation makes no representation and gives no warranty that it is the owner of the intellectual property rights in the technology described.

# OSSKAR – A positioning device for hands-free stress imaging of the knee



Available to license: A CE-marked simple medical device for stress imaging of the lower limb to enable standardised knee arthroplasty radiographs in the absence of a clinician.

The Oxford Stress System for Knee Arthroplasty Radiographs (OSSKAR) is a simple and lightweight medical device for comfortably placing patients in standardised stress positions for x-ray radiography while removing the need for a clinician.

## Partial or total knee replacement?

Unicompartmental knee replacement (UKR) has significant clinical benefits over total knee replacement (TKR), such as half the risk of venous thromboembolism, myocardial infarction or deep infection, two thirds the risk of stroke, one quarter the risk of blood transfusion and significantly lower mortality up to eight years following their operation.

However, despite being appropriate in half of patients, UKR is carried out in only 8% of cases, with large variation between centres. The main reasons for this poor adoption rate is the difficulty in identifying which patients demonstrate appropriate pathology for this procedure, such as bone-on-bone arthritis in the medial but not lateral compartment.

## The need for an informed decision

While a variety of approaches are available to investigate knee pathology, such as MRI or arthroscopy, X-ray radiography of the joint while placed in a series of standardised stress positions remains the gold standard. However, this requires either complex medical devices or the presence of a clinician. These approaches are either uncomfortable for the patient or place a costly demand on a clinician's time while exposing them to harmful x-rays (approx. 300 times a year).

## A patient and practitioner-friendly device

Researchers from the University of Oxford have developed OSSKAR, a simple hands-free device that could greatly facilitate knee stress radiography and consequently ensure all patients receive the most appropriate and cost-effective knee replacement surgery.

## Key benefits

- Simple, lightweight and inexpensive to manufacture
- CE-marked
- Allows both legs to undergo stress simultaneously
- Causes minimal patient discomfort
- Removes need for costly and invasive MRI or arthroscopy
- Removes need for manual positioning and therefore clinician radiation exposure
- Potential for horizontal beam lateral x-ray and ligament insufficiency assessment



For further information please contact:

Dr James Groves

[james.groves@innovation.ox.ac.uk](mailto:james.groves@innovation.ox.ac.uk)

+44 (0)1865 614425

[www.innovation.ox.ac.uk](http://www.innovation.ox.ac.uk)

Project number: 11194

## Technology Transfer from the University of Oxford

The information in this Project Profile is provided "as is" without conditions or warranties and Oxford University Innovation makes no representation and gives no warranty that it is the owner of the intellectual property rights in the technology described. 71

# Precision joint alignment for total knee replacement



Surgeons at the University of Oxford have developed a surgical tool capable of accurately aligning the knee joint during surgery, resulting in better surgical outcomes.

## Total knee arthroplasty

Knee arthroplasty, the process of replacing a damaged knee with an artificial joint, is considered to be a routine procedure, with the new joints lasting up to 20 years. Generally, patients undergoing knee replacements are aged between 60-80 and the most common underlying cause of the damage is osteoarthritis. In the UK, around 80,000 knee replacements are carried out each year and with an ever-ageing population, this number is only set to rise. In fact, in the US, the demand for these procedures is predicted to rise over 600% by 2030.

## Results hinge on alignment

A key step in the surgical process is aligning the new joint appropriately to correctly distribute the strain across the joint. Incorrect alignment can lead to a ligament misbalance, a cause of up to 20% of patients being unhappy with their outcome. Recently surgeons have been moving away from classical 2D mechanical alignment to employ a more complex, 3D kinematic alignment method. The kinematic method gives better outcomes as is more patient specific, however it is difficult to implement and often requires the use of patient specific surgical guides.

## Simplified alignment

Surgeons based at the world-renowned Nuffield Orthopaedic Centre, University of Oxford, have developed a surgical device capable of simply aligning the new knee in a way that is sympathetic to normal ligament function. By referencing the femoral implant, it can give accurate and reproducible alignment.

We believe the benefits of this device to be as follows:

- Simple to operate
- Accurate and reproducible alignment
- Potential applications in other joint arthroplasties
- Can be adapted to allow for conventional implant positioning

## Commercialisation

Oxford University Innovation Ltd. has filed a priority patent application, which covers this technology and is seeking partners to aid in its exploitation.



**For further information please contact:**  
**Dr Chandra Ramanujan**  
[chandra.ramanujan@innovation.ox.ac.uk](mailto:chandra.ramanujan@innovation.ox.ac.uk)  
**+44 (0)1865 614434**  
[www.innovation.ox.ac.uk](http://www.innovation.ox.ac.uk)  
**Project number: 11652**

## Technology Transfer from the University of Oxford

The information in this Project Profile is provided "as is" without conditions or warranties and Oxford University Innovation makes no representation and gives no warranty that it is the owner of the intellectual property rights in the technology described.

# Medical device facilitating improved patient experience following joint replacement



A combined motion capture and ultrasound device to improve the understanding of post-operative pain in joint replacement and develop solutions to this problem.

## Joint replacement

At £5 billion, musculoskeletal conditions account for the fourth largest NHS budget. It is estimated that 30.6 million working days are lost on an annual basis due to absence caused by a musculoskeletal conditions.

It is known that replaced joints do not have normal kinematics, however it remains unclear how far they deviate from normal. There is a clinical need for technologies to enable the design of joint replacements which offer reduced pain post-operation and kinematics closer to those seen in a healthy subject.

## Joint tracker

The current gold standards in musculoskeletal imaging are MRI and CT, with images traditionally acquired in the rested, supine position. This is clearly far from adequate for assessing patients' functional performance and response to loading such as that encountered during walking. The orthopaedics industry is looking

to ultrasound to provide radiation-free, non-invasive solutions for the assessment of joint kinematics.

Oxford orthopaedic clinicians and biomedical engineers have worked together to develop a system combining motion capture and ultrasound technologies. Further the system works to analyse the difference in joint kinematics between a healthy volunteer, a patient with a pain free knee replacement and a patient with a painful knee replacement. This is the first phase in plans to develop a portable device suited to the assessment of joints in a clinical setting.

## Commercialisation

A patent application protecting a device that combines ultrasound, motion capture and the process of tracking a subject has been filed. Prototype systems and software have been developed and applied in a clinical setting. Oxford University Innovations would like to speak with companies interested in developing a commercial product based on this technology.

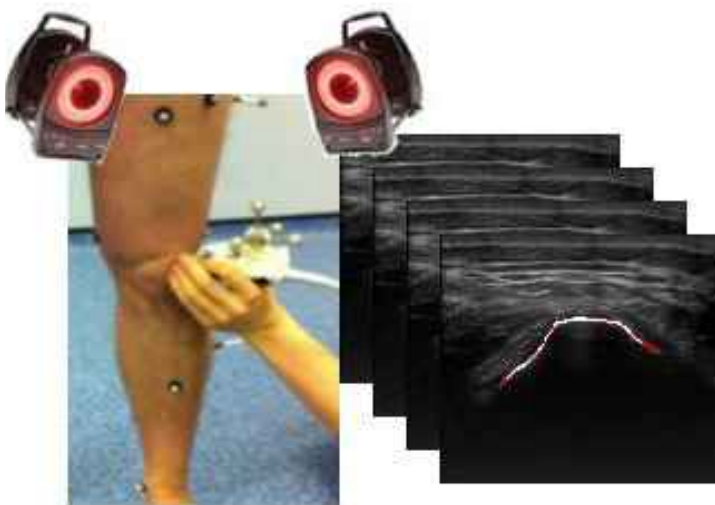

For further information please contact:  
Dr Chandra Ramanujan  
[chandra.ramanujan@innovation.ox.ac.uk](mailto:chandra.ramanujan@innovation.ox.ac.uk)  
+44 (0)1865 614434  
[www.innovation.ox.ac.uk](http://www.innovation.ox.ac.uk)  
Project number: 11979

## Technology Transfer from the University of Oxford

The information in this Project Profile is provided "as is" without conditions or warranties and Oxford University Innovation makes no representation and gives no warranty that it is the owner of the intellectual property rights in the technology described.

# Improved tools for corrective surgery of the tibia



**Available to license:** A novel system to improve the process of tibial osteotomy procedures used to correct leg alignment has been developed by Oxford University researchers and clinicians.

A team of engineers and consultant orthopaedic surgeons at the University of Oxford have developed a novel system to improve outcomes and patient experience in tibial osteotomy.

## Tibial Osteotomy

Overloading of the medial (inside) or lateral (outside) of the knee are common causes of early degenerative changes in the knee joint. High tibial osteotomy is an operation designed to realign the tibia (shin bone) to correct loading abnormalities through the knee joint. This provides an attractive 'joint preserving' surgical alternative in younger patients to joint replacement surgery which is usually reserved for later patterns of the disease.

## Out with the old...

To date the metal plates used to fix the cut bony surfaces bones in place during a tibial osteotomy have been shown to have a non-anatomical fit to the bone and can result in post-operative problems, where patients experience pain or report general dissatisfaction with the procedure. Additionally, conducting cutting and drilling of the bone during tibial osteotomy has relied on high levels of expertise and little instrumentation, with the potential for human error.

## ...and in with the new

A team of engineers and consultant orthopaedic surgeons at Oxford have developed a novel system to improve outcomes and patient experience in tibial osteotomy:

- A new generic plate design to improve patient comfort and success rates for tibial osteotomy

- A combined cutting and drilling guide for use during surgery to ensure safe and accurate plate placement
- Improved 'bespoke' wedge designs for use during surgery or as implants to form part of the corrective procedure

## Commercialisation

A patent has been filed and a series of plate, wedge and cutting guides are available. Oxford University Innovation is seeking industrial interest from parties wishing to licence and commercialise this technology.



**For further information please contact:**  
**Dr Chandra Ramanujan**  
[chandra.ramanujan@innovation.ox.ac.uk](mailto:chandra.ramanujan@innovation.ox.ac.uk)  
**+44 (0)1865 614434**  
[www.innovation.ox.ac.uk](http://www.innovation.ox.ac.uk)  
**Project number: 12527**

## Technology Transfer from the University of Oxford

The information in this Project Profile is provided "as is" without conditions or warranties and Oxford University Innovation makes no representation and gives no warranty that it is the owner of the intellectual property rights in the technology described.



# Targeted imaging agent as a companion diagnostic and prognostic for osteoarthritis



**Available to license:** Targeted contrast agent for computer tomography (CT) as a tool for imaging damaged cartilage in patients with osteoarthritis

Oxford researchers have developed an approach to CT contrast which rapidly creates peptides containing sufficient quantities of iodine to facilitate imaging studies.

## Diagnosis and monitoring of osteoarthritis

Osteoarthritis is a common condition characterised by the deterioration of the protective cartilage on the ends of bones, thus provoking pain and stiffness in joints, most commonly in knees, hips and small joints of the hands. The FDA recognises it as a serious disease with an unmet medical need. There is a lack of therapies that treat the underlying pathophysiology of the disease and potentially change its natural course to prevent long-term disability. The absence of a method to reliably assess the ability of a drug to alter the disease progression is among the reasons for such treatment deficiency.

While X-ray imaging remains an insensitive method as the cartilage is invisible under such scanning and MRI imaging shows low resolution with weak biochemical basis for change, contrast computerised tomography (CT) makes cartilage visible during the scanning.

CT contrast is commonly provided by injection of iodine containing chemicals which increases the visibility of blood as it flows through the circulatory system.

While imaging modalities such as positron emission tomography (PET) provide access to disease targeted imaging agents for the imaging of specific cancers or neurological diseases, no targeted agents are currently available for CT contrast.

## Targeted computerised tomography

Researchers at Oxford have tackled this limitation and developed a novel and long lasting CT contrast imaging agent for cartilage tissues based on iodine-containing peptides.

The technology provides:

- A new tool for osteoarthritis prognosis

- Lower cost implications compared to MRI, PET and SPECT
- Higher accessibility since CT scanners are more commonplace than their MRI counterparts

Although proof-of-concept work has been conducted in osteoarthritis, the same technique could be applied to a wide range of indications that can be targeted by peptide-based imaging, meaning that targeted CT contrast using iodinated peptides could be a game changer in the clinical management of a great numbers of patients.

## Commercialisation

Oxford University Innovation has filed a patent with scope for international protection of a broad scope of radiopaque peptides and compounds. Commercial partners with an interest in licensing this technology or partnering for further clinical development are currently sought.

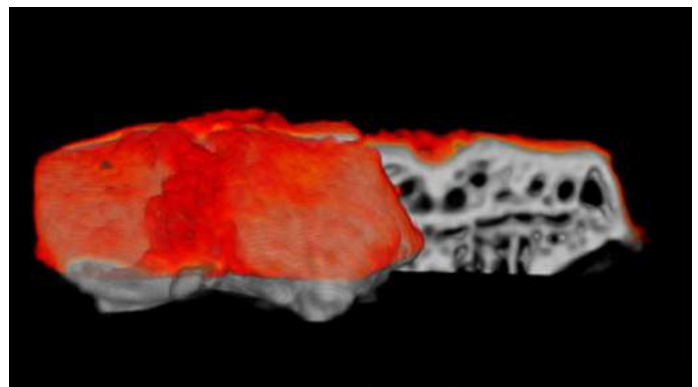

**For further information please contact:**

**Iraida Soria Espinosa**

**[iraida.soriaespinosa@innovation.ox.ac.uk](mailto:iraida.soriaespinosa@innovation.ox.ac.uk)**

**+44 (0)1865 614453**

**[www.innovation.ox.ac.uk](http://www.innovation.ox.ac.uk)**

**Project number: 13952**

## Technology Transfer from the University of Oxford

The information in this Project Profile is provided "as is" without conditions or warranties and Oxford University Innovation makes no representation and gives no warranty that it is the owner of the intellectual property rights in the technology described.

# Head extractor tool for total orthopaedic hip replacement



Engineers at Oxford University and orthopaedic surgeons at West Middlesex University Hospital have designed and prototyped a novel surgical tool to improve the surgical procedures and outcomes of revision hip arthroplasty.

## Limitations with current practices

Total hip arthroplasty is one of the most successful and cost-effective orthopaedic interventions performed today, with 310,000 procedures performed each year in the US. Approximately 2.5 million Americans are living with an artificial hip and this number continues to increase every year. In 10 to 15 percent of cases, patients will develop issues with their hip replacement, such as severe discomfort and pain, which requires revision surgery.

Currently there is no common practice and no dedicated tool for easily separating the implant head component from the stem, which results in varying degrees of success for the procedure. The separation itself can be extremely challenging, requiring a lot of energy from the surgeon, which can result in bone damage, longer operating times and increased financial costs.

## A surgical tool designed for the task

Engineers at the University of Oxford and consultant orthopaedic surgeons at West Middlesex University Hospital have developed a novel surgical tool to improve the surgical procedures and outcomes of revision hip arthroplasty. This one-part re-usable tool has been designed to safely and quickly extract the head from a hip prosthetic implant without displacing the stem part.

Using mechanical analysis, the tool design has been optimised to allow the surgeon to position the tool accurately before applying a force, to adjust the mechanism to a comfortable working position and to control the force applied.

## Advantages provided by a dedicated tool

The Oxford device provides the following advantages:

- Compatible with wide range of head-stem combinations
- Adjustable for any size head, including over 40mm heads
- Suitable for primary hip arthroplasties

A patent has been filed and a stainless-steel prototype is available. Oxford University Innovation is seeking industrial interest from parties wishing to licence and commercialise this technology.

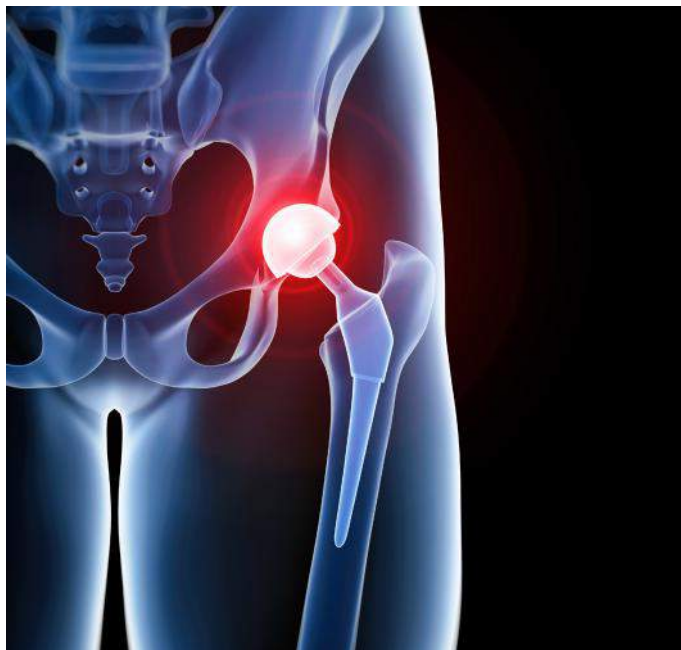

**For further information please contact:**  
**Bénédicte Menn**  
[benedicte.menn@innovation.ox.ac.uk](mailto:benedicte.menn@innovation.ox.ac.uk)  
**+44 (0)1865 280906**  
[www.innovation.ox.ac.uk](http://www.innovation.ox.ac.uk)  
**Project number: 14859**

## Technology Transfer from the University of Oxford

The information in this Project Profile is provided "as is" without conditions or warranties and Oxford University Innovation makes no representation and gives no warranty that it is the owner of the intellectual property rights in the technology described.

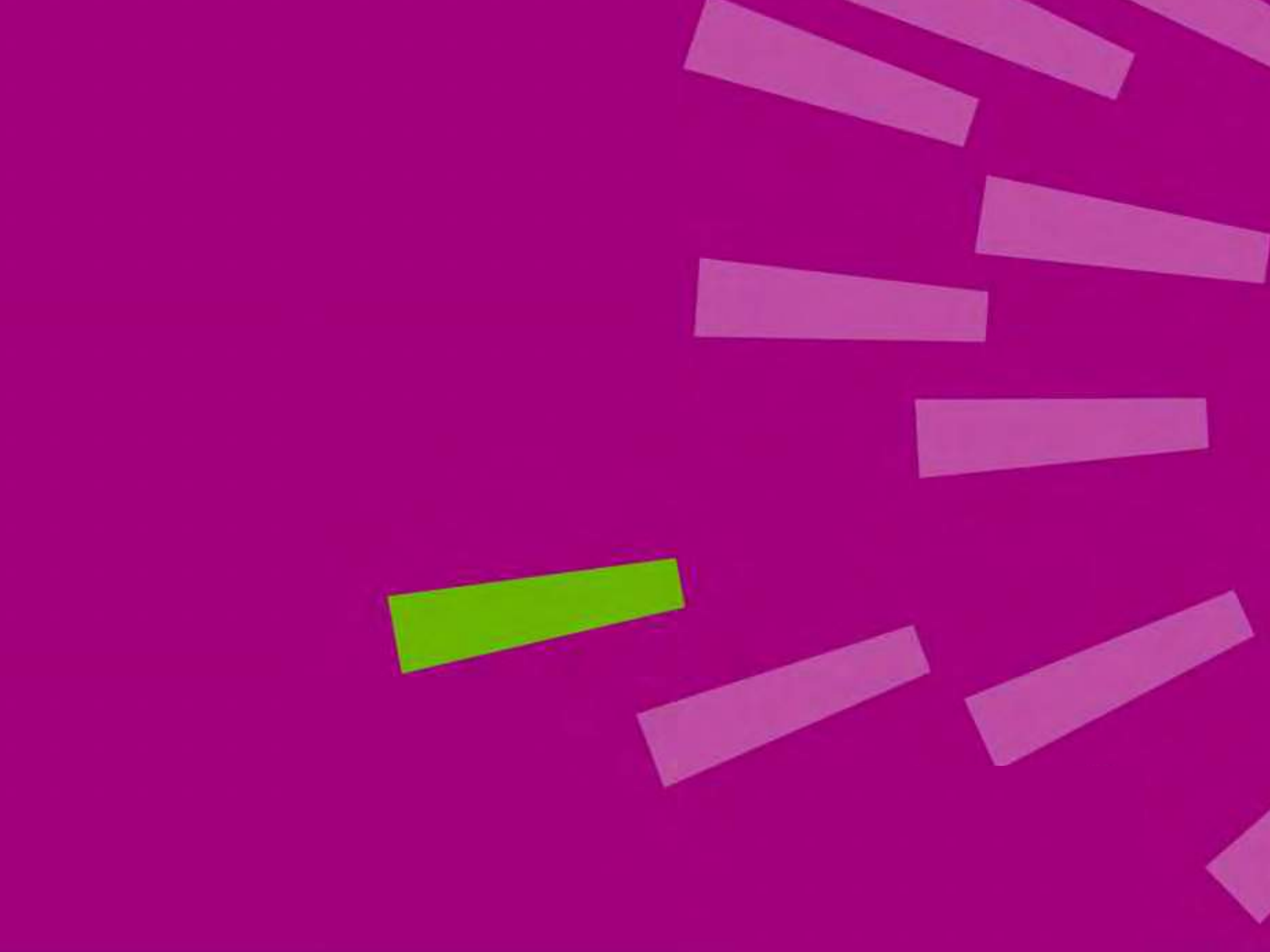

# PRODUCTION/ MANUFACTURING

# Tissue bioreactor for drug discovery and tissue engineering applications



A novel device enabling the culture of cellular tissue that is conditioned to the mechanical forces found in the human body, suitable for drug discovery or tissue engineering applications.

Researchers at the University of Oxford have developed a contactless mechanically-enhanced tissue culturing technology which offers control over the mechanical loads exerted on the growing tissue.

The device is capable of exerting a range of precise, temporally and specially controlled forces on tissue cultures that closely mimic real-world conditions. All of the forces exerted are frictionless and contactless. This is in contrast to existing solutions which generally involve contact with the sample or tissue and are only unidirectional.

This new device has multiple applications, these include the development of an *in vitro* drug discovery platform, a novel drug delivery methodology, and the conditioning of engineered tissues in preparation for human tissue transplantation.

## Stretching for perfection: Optimising tissue conditioning for transplantation

The process of evolution has produced human tissues that are optimised for their function. These tissues are also able to adapt during our lifetime to the kind of loading they experience. For example, the forearm bones of elite tennis players are stiffer and denser on their serving side.

Prior to implantation in humans, it is vital that synthetic tissue has been conditioned to receive mechanical loads whilst maintaining a sterile environment. Tissue cultured using the Oxford invention demonstrated excellent viability and mechanical properties equivalent to fresh samples. Relevant tissues include muscle, tendon, cartilage and bone.

## Reduction of animal experiments via *in vitro* drug screening

In recent years there has been a concerted effort by scientists and researchers to move away from the use of

animals to screen drug candidates. Alternative solutions capable of mimicking *in vivo* conditions are generally under—developed.

The Oxford device allows for drugs to be screened in an *in vitro* environment, which more closely simulates *in vivo* mechanical conditions and stresses.

## Seeking a commercialisation partner

Prototypes have been built and tested and a patent application has been filed in a number of territories worldwide.

Oxford University Innovation is keen to talk to drug development, tissue culture or tissue engineering and bioreactor manufacturing companies interested in licensing this technology.

The technology readiness level is TRL 4.

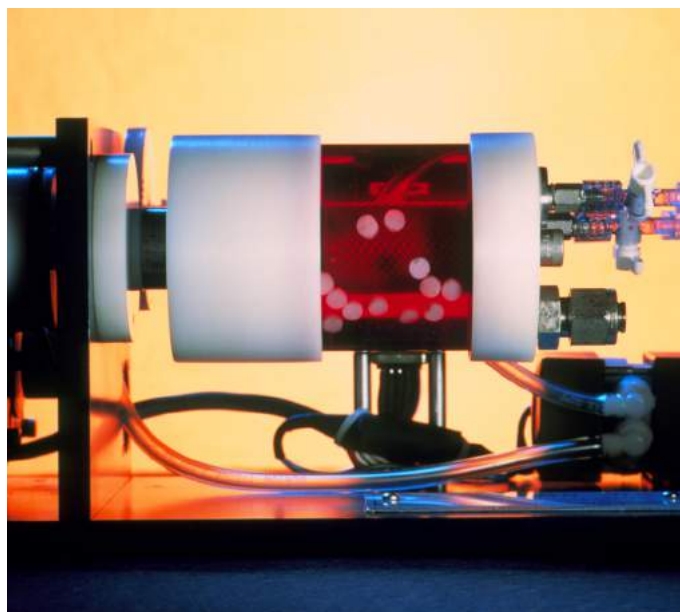

For further information please contact:  
**Andrew Chan**  
[andrew.chan@innovation.ox.ac.uk](mailto:andrew.chan@innovation.ox.ac.uk)  
**+44 (0)1865 614422**  
[www.innovation.ox.ac.uk](http://www.innovation.ox.ac.uk)  
**Project number: 11475**

## Technology Transfer from the University of Oxford

The information in this Project Profile is provided "as is" without conditions or warranties and Oxford University Innovation makes no representation and gives no warranty that it is the owner of the intellectual property rights in the technology described.

# Increasing the stability and biocompatibility of chemically synthesised oligonucleotides



Oxford researchers have developed a chemical synthesis strategy for producing DNA incorporating non-natural backbone structures and locked nucleic acid functions which convey desirable properties such as more selective and robust binding to complementary nucleic acids and greater resistance to enzymatic degradation.

## Nucleic acids – Encoding life

DNA and RNA are biomolecules that are fundamental to all known forms of life. In recent years, many successful attempts have been made to harness the myriad functions of nucleic acids and apply them in the fields of human medicine, forensics and genetic testing. In general, these applications use DNA and or RNA produced through well-established solid phase synthesis methods. These mostly contain chemical modifications that have been established for very many years. Emerging applications, particularly in therapeutics, require more robust nucleic acid structures, with customisable properties to improve *in vivo* stability and delivery, so new designs and synthetic approaches are required.

## New nucleic acid analogues - Improving on nature

To meet the demand for increased efficacy created by breakthroughs such as the recent development of several clinically approved therapeutic oligonucleotides, researchers have sought novel nucleic acid analogues. One such approach utilises azide-alkyne “Click” chemistry to generate a triazole surrogate of the natural phosphodiester backbone. However the presence of such groups in the DNA/RNA backbone renders the resulting biomolecules unable to efficiently bind (by Watson-Crick base pairing) to complementary DNA/RNA sequences. The selectivity and strength of this binding is crucial to its application.

## LNA – Locking in new features

Researchers at the University of Oxford have exploited the triazole linkage in combination with locked nucleic acids (LNAs) to yield oligonucleotides which display higher target binding affinities and greater resistance to enzymatic degradation. In addition, reagents have been developed which allow for easy incorporation of this functionality by standard automated solid phase synthesis methods.

The main benefits of the Oxford Triazole-LNA approach are as follows:

- Significant increase in DNA:RNA duplex stability (target affinity) compared to triazole alone
- Less susceptibility to enzymatic degradation than native DNA/RNA
- Synthesis by rapid, efficient and scalable solid phase techniques
- Ability to modulate or eliminate anionic charge on DNA/RNA analogue

## Protection and Applications

This technology is the subject of two patent applications and Oxford University Innovation is keen to talk to anyone who is interested in their commercialisation.



For further information please contact:

Susan Campbell

[susan.campbell@innovation.ox.ac.uk](mailto:susan.campbell@innovation.ox.ac.uk)

+44 (0)1865 6 14481

[www.innovation.ox.ac.uk](http://www.innovation.ox.ac.uk)

Project number: 14808, 14955

## Technology Transfer from the University of Oxford

The information in this Project Profile is provided "as is" without conditions or warranties and Oxford University Innovation makes no representation and gives no warranty that it is the owner of the intellectual property rights in the technology described.

# Electrocatalytic nanoparticles - Nafion<sup>®</sup> nanostructures doped with redox active species



Researchers at the University of Oxford have developed a simple synthesis route to Nafion<sup>®</sup> nanoparticles doped with redox active cationic species such as Ru(bpy)<sub>3</sub><sup>2+</sup> or methylviologen.

## Redox cation doped Nafion<sup>®</sup> nanoparticles

Researchers at the University of Oxford have developed a simple synthesis route to Nafion<sup>®</sup> nanoparticles doped with redox active cationic species such as Ru(bpy)<sub>3</sub><sup>2+</sup> or methylviologen. These nanostructures display the similar facile oxidation/reduction properties as the solution phase cations. The supported catalysts are easily removed from reaction mixtures through filtration or centrifugation, thus reducing wastage. These nanoparticles could be applied to sensors, fuel cells and imaging. We believe the benefits of the redox cation doped Nafion<sup>®</sup> nanoparticles are as follows:

- Simple manufacture and recovery
- Inert and stable Nafion<sup>®</sup> support
- Incorporated cations retain their redox reactivity
- Myriad applications due to the range of cations that can be selected for use

## Ru(bpy)<sub>3</sub><sup>2+</sup> - The current face of electrocatalysis

Electrocatalysts are a subset of catalysts that operate at the surface of an electrode. Ruthenium (II) tris(2,2'-bipyridyl) (Ru(bpy)<sub>3</sub><sup>2+</sup>) is a widely used electrocatalyst due to its accessible oxidation potential of 1.27 V vs SCE. The ability to electrochemically generate excited states of Ru(bpy)<sub>3</sub><sup>2+</sup> is also attractive as, upon relaxation to a ground state, such species will luminesce. The wavelength of the emitted photon is around 620nm, so will appear as red light.

In a separate application electrochemiluminescence (ECL) exploits the generation of excited species in an electrochemical reaction, which emits light upon relaxation to a lower-level state. ECL has been used in bioanalytical applications (DNA detection and Immunoassays), with Ru(bpy)<sub>3</sub><sup>2+</sup> featuring as the ECL reagent of choice. Ru(bpy)<sub>3</sub><sup>2+</sup> possesses excellent stability, a wide range of analyte tolerance and compatibility with

many separation techniques. Numerous attempts have been made to immobilise Ru(bpy)<sub>3</sub><sup>2+</sup> on electrochemically inert substrates to aid with catalyst recovery and stability, however, success has been limited.

## Transforming homogeneous redox chemistry into heterogeneous electrocatalysis

The developed methodology enables any homogeneous redox based chemical reaction involving cations as reagents to be transformed into an electrochemically driven catalytic process. It will transform redox solution phase chemistry by making it heterogeneous and catalytic.

## Patent protection

A UK priority patent has been filed to protect this technology, and Oxford University Innovation Ltd. is looking to hear from anyone interested in helping in its commercialisation.



For further information please contact:  
Dr Chandra Ramanujan  
[chandra.ramanujan@innovation.ox.ac.uk](mailto:chandra.ramanujan@innovation.ox.ac.uk)  
+44 (0)1865 614434  
[www.innovation.ox.ac.uk](http://www.innovation.ox.ac.uk)  
Project number: 15101

## Technology Transfer from the University of Oxford

The information in this Project Profile is provided "as is" without conditions or warranties and Oxford University Innovation makes no representation and gives no warranty that it is the owner of the intellectual property rights in the technology described.

# New method for the characterisation of amorphous complex mixtures



Oxford researchers have developed an algorithm for the identification of individual chemical components in an amorphous formulation.

## Amorphous components in complex formulations

The analysis of mixtures is of particular interest in the development of pharmaceuticals due to regulations and quality control requirements. Although there are a number of techniques currently available for this purpose, the characterisation of amorphous components in complex formulations remains a challenge.

Amorphous solid dispersions (ASDs) comprise an amorphous active pharmaceutical ingredient (API) dispersed in a water-soluble polymer binder. They are commonly used to improve the solubility and bioavailability of the API, making them key in the development of pharmaceuticals. Due to the amorphous nature of ASDs, their stability is poorly understood with re-crystallisation of the API being the most likely cause of a formulation decomposing. In reality, ASDs often contain the API in both amorphous and crystalline form. As the amorphous API is essential to the function of the drug, methods for its characterisation and quantification within the complex formulation are essential. ASDs are currently studied through mass spectroscopy, nuclear magnetic resonance and infrared spectroscopy; however, such techniques struggle to quantify ASDs for formulation purposes and are limited in determining the crystallinity of the API in the ASD.

## Novel algorithm for scattering data analysis: characterisation of APIs

Academics at Oxford have tackled such limitation and developed a general and robust method for the characterisation of APIs in complex formulations. The technology relies on diffraction experiments performed on complex mixtures and uses an algorithm to extract the resulting scattering data from each component's contribution.

### The new method allows:

- the structural characterisation of an amorphous API in the mixture
- the quantification and monitoring of the crystallinity, which makes possible:

- the determination of the maximum API loading level capable of inhibiting crystallisation
- the identification of drug design strategies for improving stability of the amorphous form

### Advantages of the algorithm includes:

- ease of use
- versatility as it can be applied to other experimental datasets including spectroscopy data
- computationally inexpensive
- This same methodology is readily transferable to the study of other complex mixtures beyond those mentioned, such as battery materials, heterogeneous catalysts, and liquid fuels.

### Commercialisation

Oxford University Innovation Ltd. has filed an international patent application (PCT) on the technology (WO 2019/180430A1) and welcomes discussions with companies interested in licensing it for commercial development.

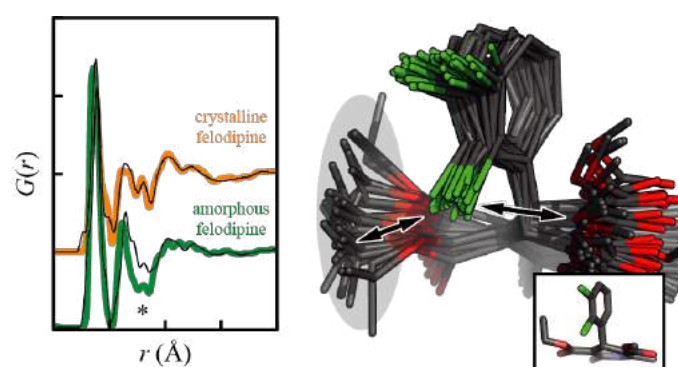

**Above image:** The method enables experimental signatures of both the crystalline and amorphous form of the API to be determined; which allows structural characterisation of the amorphous API in ASDs.

### For further information please contact:

Dr Jane Jin  
jane.jin@innovation.ox.ac.uk  
+44 (0)1865 614458  
www.innovation.ox.ac.uk  
Project number: 15349

## Technology Transfer from the University of Oxford

The information in this Project Profile is provided "as is" without conditions or warranties and Oxford University Innovation makes no representation and gives no warranty that it is the owner of the intellectual property rights in the technology described.

University of Oxford researchers utilise proteins in a key pathway involved in regulating plant development to improve crop yields and stress tolerance.



Plant cells contain a unique complement of organelles that are entirely absent from all animal cells. The organelles are termed plastids, which function as plant cell chemical factories and storage facilities. Plastids are critical for plant development and numerous important functions and include chloroplasts (photosynthesis), amyloplasts (starch storage), elaioplasts (fatty acid storage) and chromoplasts (fruit ripening). They also play critical roles in the adaptation of plants to their surroundings.

A specific feature of plastids is their ability to switch (also known as transition or interconvert) between plastid types in response to certain cues. These transitions are crucial for plant development and are a key means through which plants can adapt to a changing environment. The transitions rely on proteins that are made within the plant cytosol being imported into plastids via a pathway that includes the TIC/TOC proteins. TIC and TOC are translocon complexes located on the inner and outer membranes of plastids. Modifications to key components of TIC/TOC have been shown to directly affect plastids.

The TIC/TOC pathway can therefore be used as a novel method to regulate a variety of plant functions and thereby control

performance traits. Researchers at the University of Oxford have identified two entirely novel proteins that act within the TIC/TOC pathway. One of the proteins has been termed SP2; this is a retrotranslocation channel that enables the extraction of ubiquitinated proteins from the plastid membranes. The second protein is known as PUX10 and is required to recruit a cytosolic chaperone (CDC48) to the plastid surface, where the latter then drives the extraction process. These proteins represent key steps in the TIC/TOC pathway.

The Oxford researchers envisage that by manipulating SP2 and PUX10 they will be able to regulate plant development. They envisage that altering the expression of SP2 and/or PUX10 can promote stress tolerance or delay leaf senescence, to induce a “stay green” phenotype, thereby promoting yield increases and enhanced plant health, or alter fruit ripening.

**For further information please contact:**

**Dr Richard Auburn**

**[richard.auburn@innovation.ox.ac.uk](mailto:richard.auburn@innovation.ox.ac.uk)**

**+44 (0)1865 280956**

**[www.innovation.ox.ac.uk](http://www.innovation.ox.ac.uk)**

**Project number: 15513, 15608**

## Technology Transfer from the University of Oxford

The information in this Project Profile is provided "as is" without conditions or warranties and Oxford University Innovation makes no representation and gives no warranty that it is the owner of the intellectual property rights in the technology described.



Researchers at the University of Oxford have developed a novel technique for ensuring monoclonality in a well plate for workflows that rely on single cell isolation.

Single cell isolation is a core part of many biologically important workflows, such as monoclonal antibodies (mAbs) production, stem cell therapy and gene editing. For such applications, it is essential to be able to confirm that a selected colony derives from a single cell to ensure high quality data for research projects and to meet regulatory requirements in a commercial environment.

Several different methods for ensuring monoclonality have been established. For example, fluorescence-activated cell sorting (FACS) can be used to allow fluorescently labelled cells to be sorted and ensure their isolation. Further, simple optical devices can be used to capture images of and examine individual wells holding biological matter. However, these existing methods are time-consuming and prone to difficulties.

## Fluorescence activated cell sorting (FACS)

FACS can adversely affect cell viability whilst existing methods of examining wells can lead to uncertainty due to what is known as the “edge-effect”. With conventional methods of examining wells, identifying cells in the region where the well base meets the vertical well wall is particularly difficult as dark/blurred regions in images can occur due to well edge artefacts. Even capturing images of cells situated within and close to the boundary of the droplet can prove problematic due to unwanted optical effects at the interface of the droplet.

## Technologies for single cell isolation

Through appreciating the problems with existing methods, researchers at the University of Oxford have developed a new technique for ensuring monoclonality in droplets for both industrial and research workflows.

The objective behind this new method is to enhance optical clarity by using discrete drops in well plates,

thereby eliminating the “edge effect” problems that occur with well plate walls. Further, using this novel arrangement, individual droplets holding cell matter can be “flattened” to provide complete clarity over the entire drop region and provide more certainty over the presence of no, one or a plurality of cells.

## Patent protection

The methodology is the subject of a patent application. Oxford University Innovation is actively seeking commercial partners to help commercialise the technology in existing industrial workflows and take an exclusive market position in relation to it.



For further information please contact:

**Ben Oakley**

[ben.oakley@innovation.ox.ac.uk](mailto:ben.oakley@innovation.ox.ac.uk)

+44 (0)1865 280869

[www.innovation.ox.ac.uk](http://www.innovation.ox.ac.uk)

Project number: 15782

## Technology Transfer from the University of Oxford

The information in this Project Profile is provided "as is" without conditions or warranties and Oxford University Innovation makes no representation and gives no warranty that it is the owner of the intellectual property rights in the technology described.

# Bespoke reference electrode for electrochemical sensors



Oxford researchers have developed a novel solid-state electrolyte-free reference electrode suitable for miniaturisation.

## The use of reference electrodes

High quality reference electrodes, are essential in all electrochemical experiments embracing both amperometric and potentiometric. They are fundamental units in the many chemical sensors which rely on such electrochemical measurements including glucose sensors and fire alarms.

The stability and robustness of a reference electrodes is key for its success as they dictate the sensitivity and longevity of a sensors.

The most popular reference electrode is the silver/silver chloride electrode. This is widely used in pH meters and often the reference electrode of choice in redox potential measurements as well as in a numerous biosensors including those built on screen printed electrodes. For a stable and reproducible potential, a fixed chloride concentration is crucial and this is achieved by having a Ag/AgCl surface in contact with a solution of potassium chloride of a fixed molarity inside or bathing the electrode.

Such requirements are often problematic in applications in which the reference electrode needs to be miniaturised or when the reference electrode is used in flowing solutions. Losses of AgCl from the electrode surface are well known and are the cause of contamination, potential drift, and loss of electrode stability. Alternatives are needed to drive forward and facilitate the highly active area of (electro-) chemical sensing.

## Nafion film based reference electrodes

Researchers at Oxford have addressed these limitations through a bespoke design and developed a solid state electrolyte-free reference electrode in which the two components of a redox couple are uniquely immobilised on a Nafion film supported on a metal surface.

## Advantages of this novel technology include:

- Simple fabrication
- Deployable on any metal surface
- Readily miniaturised
- Avoids leaching or continuation problems
- Excellent stability and lifetime
- Disposable

In summary, the doped Nafion film based reference electrode is a robust alternative to the silver/silver chloride reference electrode. Miniaturisation would allow for applications in analytical devices at all scales, as well as in disposable sensors.

## Commercialisation

Oxford University Innovation has filed a priority patent application on the technology and welcome discussion with companies interested in licensing it for commercial development.



**For further information please contact:**  
**Dr Jamie Ferguson**  
[jamie.ferguson@innovation.ox.ac.uk](mailto:jamie.ferguson@innovation.ox.ac.uk)  
**+44 (0)1865 280851**  
[www.innovation.ox.ac.uk](http://www.innovation.ox.ac.uk)  
**Project number: 16771**

## Technology Transfer from the University of Oxford

The information in this Project Profile is provided "as is" without conditions or warranties and Oxford University Innovation makes no representation and gives no warranty that it is the owner of the intellectual property rights in the technology described.



# RESEARCH TOOLS

# Adaptive animal tracking tags



Available to license: Hardware designs/software for smart animal tracking.

Exploiting a compression algorithm to reduce data volumes, this flexible, wireless technology has already demonstrated excellent reliability in the field.

In order to increase their understanding of animal behaviour and habits, zoologists are seeking improved methods for monitoring animals continuously in their natural environments.

Researchers from the Departments of Computer Science and Zoology at the University of Oxford have developed a new generation of ultra-low power, wireless tracking tags capable of monitoring animals continuously in the field.

## Efficiency

The technology is based on the use of a very efficient compression algorithm to reduce data volumes, which saves energy both in storage and transmission of information.

The technology can also be configured to upload data in a progressive manner, with increasing levels of detail. This can be used to reduce the risk of wholesale data loss from destruction of tags before uploading is complete.

## Versatility

There is a large amount of inherent flexibility in the solution, with the smart tags capable of being configured to run in many different ways. The smart tags are able to perform on-board streaming compression and rate adaptive sampling, compared to current tags which generally can only act as data loggers.

## Market readiness

Having been field tested over many months with excellent reliability, this technology can be considered to be at a high level of readiness for commercial use.

The hardware designs and software for the smart animal tracking tags are protected by copyright.

Oxford University Innovation would like to talk to organisations involved in wildlife and conservation research interested in licensing this technology.



**For further information please contact:**  
**Marina Fuentes Sainz**  
[marina.fuentessainz@innovation.ox.ac.uk](mailto:marina.fuentessainz@innovation.ox.ac.uk)  
**+44 (0)1865 614423**  
[www.innovation.ox.ac.uk](http://www.innovation.ox.ac.uk)  
**Project number: 9192**

## Technology Transfer from the University of Oxford

The information in this Project Profile is provided "as is" without conditions or warranties and Oxford University Innovation makes no representation and gives no warranty that it is the owner of the intellectual property rights in the technology described.

The low-cost, disposable electrodes can be harnessed for in-field detection and quantification of nanoparticles

The antibacterial and antiseptic effect of silver nanoparticles (Ag NPs), in combination with their cost-efficient mass production, has resulted in their use in a wide variety of consumer and medical products. The omnipresence of these nanoparticles and their corresponding release into the environment, in combination with their unknown effect on environmental systems, raises the demand for reliable and affordable techniques for their detection.

## Limitations of current detection and characterisation

A number of methods including light scattering, nanoparticle tracking analysis and UV/visible measurements have been successfully used to determine the composition, concentration, size, surface charge density, adsorption and agglomeration of NPs in various systems, including real environmental samples. A limitation of these methods is that liquid samples have to be taken, transported and analysed. This carries the risk of causing changes to the sample, for example by altering the concentration or aggregation state.

## Oxford developments

Oxford researchers have developed a novel approach to Ag NP detection, with potential application for long-term field studies and environmental monitoring. Their method uses specially surface-modified glassy carbon electrodes. These “sticky” electrodes are immersed into the medium of interest, the NPs are allowed to stick to the surface over a period of time, and then the amount of NPs immobilised on the electrode surface is analysed either in the field or in the laboratory.

## Advantages

The use of sticky electrodes enables a long sampling time and thus detection of NPs even from media with low concentrations of NPs. The sample can be collected

on site without an applied electric potential, i.e. under open circuit conditions. As a result, there is no need to base expensive and sensitive equipment on site. Analysis may be carried out back at the laboratory with a much reduced risk of the sample being changed by transportation. The modified carbon electrodes lend themselves to manufacture via screen printing and therefore have potential to offer a commercial partner a low cost and disposable solution.

## Supporting data

The Oxford developments are described in Chemical Communications (2013), entitled “Sticky electrodes for the detection of silver nanoparticles.” Please also refer to related Isis Project No. 7909, “Electrochemical detection of silver nanoparticles.”

## Moving forward

The underlying technology is the subject of a UK patent application. Oxford University Innovation is seeking external partners to support the commercialisation of the technology.

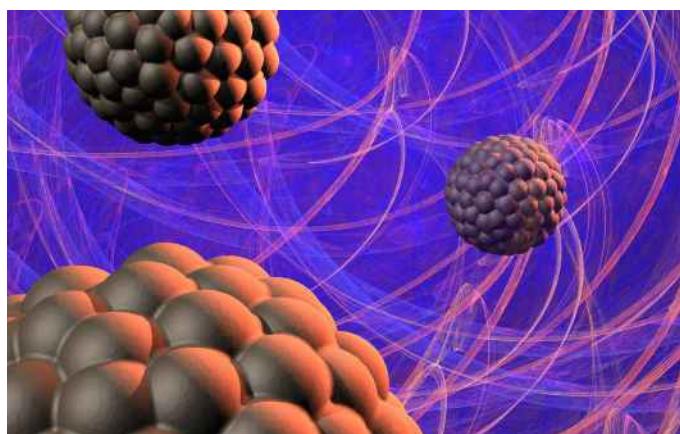

**For further information please contact:**  
**Dr Chandra Ramanujan**  
[chandra.ramanujan@innovation.ox.ac.uk](mailto:chandra.ramanujan@innovation.ox.ac.uk)  
**+44 (0)1865 614434**  
[www.innovation.ox.ac.uk](http://www.innovation.ox.ac.uk)  
**Project number: 10098**

## Technology Transfer from the University of Oxford

The information in this Project Profile is provided "as is" without conditions or warranties and Oxford University Innovation makes no representation and gives no warranty that it is the owner of the intellectual property rights in the technology described.

# IMPACT: Rapid calculation of protein structural parameters



**Available to license:** An algorithm and software implementation to rapidly calculate the size of proteins with applications in structural biology and proteomics.

The IMPACT (Ion Mobility Projection Approximation Calculation) algorithm developed by Oxford researchers offers a  $10^6$ -fold increase in speed without a significant drop in accuracy.

## Protein structure-function correlation

The structure of proteins and multi-component protein assemblies is closely related to their function in biological systems. Knowing the detailed structure of a protein enables analyses of protein function. Methods for the accurate and efficient determination of key structural parameters are vital.

The development of new structure determination methods and improvements to existing methods are critical to advancing the fields of both proteomics and structural biology.

## Collision Cross Sections (CCSs)

The Collision Cross Section (CCS) gives an accurate measurement of the size of a protein or protein cluster and can be directly used to predict interactions between multiple proteins and/or between proteins and other biological molecules. A significant bottleneck arises in making structural sense of the CCSs.

## IMPACT (Ion Mobility Projection Approximation Calculation Tool)

Oxford researchers have developed the IMPACT algorithm which achieves a  $10^6$ -fold efficiency increase in the calculation of CCSs when compared to IM-MS data. Whereas existing methods could take approximately 1 day to calculate the CCS for a moderately sized protein, IMPACT arrives at the same result in 0.07s.

The key advantages of this technology include:

- $10^6$ -fold increase in efficiency

- No significant drop in accuracy
- Interface allows integration with other software
- Readily mimics more rigorous methods
- Already adopted by more than 150 academic laboratories

This algorithm could be used to ensure gas phase experiments can be used in a superfast method for calculating CCSs and ultimately enable modelling solution-phase separation of proteins. Oxford University Innovation is seeking external partners that wish to use this proprietary software.

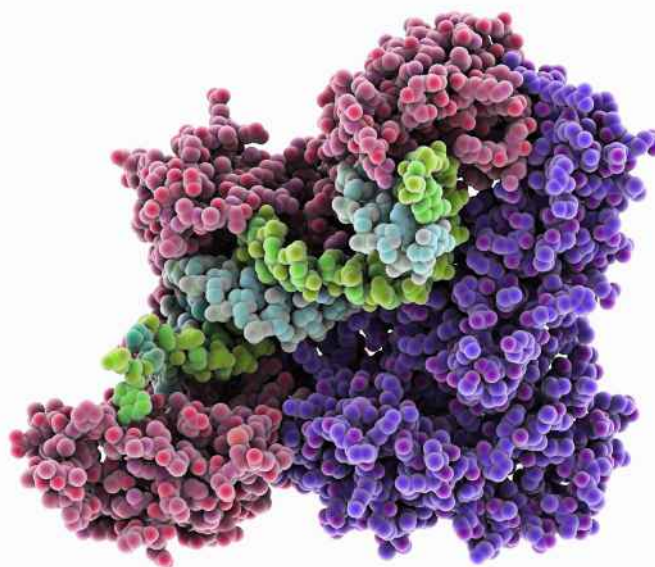

**For further information please contact:**  
**Dr Richard Auburn**  
[richard.auburn@innovation.ox.ac.uk](mailto:richard.auburn@innovation.ox.ac.uk)  
**+44 (0)1865 280956**  
[www.innovation.ox.ac.uk](http://www.innovation.ox.ac.uk)  
**Project number: 10126**

## Technology Transfer from the University of Oxford

The information in this Project Profile is provided "as is" without conditions or warranties and Oxford University Innovation makes no representation and gives no warranty that it is the owner of the intellectual property rights in the technology described.

# MAGMA: Automated assignment of NMR spectra for proteins and complexes



**Available to license:** MAGMA enables automated assignment of Nuclear Magnetic Resonance (NMR) spectra for proteins, small molecules and intermolecular complexes of proteins and small molecules.

Oxford researchers have developed a method for the robust assignment of methyl Transverse Relaxation Optimised Spectroscopy (TROSY) spectra.

## Probing the structure and dynamic behaviour of proteins and complexes

NMR spectroscopy has become an essential tool for solution state studies of proteins and other macromolecules. NMR spectroscopy simultaneously provides information about the structure and dynamics of biomolecules at an atomic resolution, thereby enabling analyses of protein folding, denaturation, folding intermediates and transition states, conformational and dynamic behaviour of a biomolecule, ligand binding and mapping of binding sites.

## Pushing the limits

Traditional NMR techniques have provided a wealth of information about small proteins, up to approximately 30 kDa in weight. Translating NMR to the study of larger macromolecules has proved challenging. Methyl TROSY (Transverse Relaxation Optimised Spectroscopy) has recently been developed to provide information on the structure and dynamic behaviour of protein complexes up to 1 MDa in weight: capturing 99% of the human proteome.

Despite the ability to push beyond the traditional weight limit, the assignment of methyl TROSY spectra is presently time-consuming and cost-prohibitive.

## An automated assignment

Currently, assignment of methyl TROSY spectra is typically performed using (multiple rounds of) single point mutagenesis. This requires multiple expensive samples and can provide high cost but potentially unreliable data. Oxford researchers have developed a method that automatically assigns the residues whilst eliminating the need for or enabling targeted (informative) in situ mutagenesis.

Advantages of the Oxford method:

- The graphical user interface supports processing raw data and picking spectral resonances

- Compatible with 'NMR pipe' (from NIH) and 'Topspin' (from Bruker)
- time and cost effective ( $10^5$  faster than MAGMA v1)
- measurements taken on a wild-type sample
- provides all feasible solutions, with a confidence fit to direct downstream analyses
- robust data analysis in the presence of artefacts, incomplete detection of resonances, presence of impurities and other sources of experimental error

Application of this highly disruptive method removes a key barrier to the widespread adoption of methyl TROSY NMR. Thereby enabling usage of this and related NMR techniques for drug, agrichemical and nutraceutical discovery programmes. By using solution NMR, the Oxford researchers were able to experimentally measure inter-methyl distances from the NOESY data. The method has been extensively tested, and the technique is the subject of a patent application. Oxford University Innovation is seeking commercial partners with an interest in incorporating this technique into their discovery programmes.

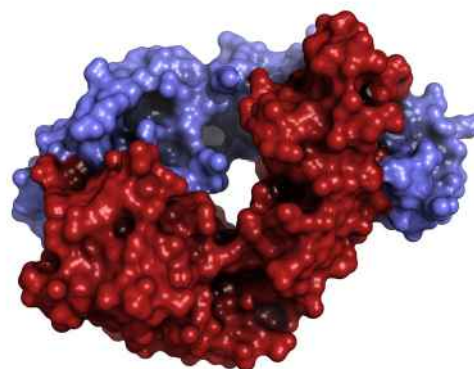

**For further information please contact:**  
**Dr Richard Auburn**  
[richard.auburn@innovation.ox.ac.uk](mailto:richard.auburn@innovation.ox.ac.uk)  
**+44 (0)1865 280956**  
[www.innovation.ox.ac.uk](http://www.innovation.ox.ac.uk)  
**Project number: 12970, 15255, 15640**

## Technology Transfer from the University of Oxford

The information in this Project Profile is provided "as is" without conditions or warranties and Oxford University Innovation makes no representation and gives no warranty that it is the owner of the intellectual property rights in the technology described.

**Available to license:** Software for the analysis of protein structures from the atomic level up to multimeric quaternary structures.

Researchers at the University of Oxford have developed BiobOx, a structural biology tool, which allows users to analyse and manipulate protein structures, incorporating data from electron density maps and collisional cross sections.

## Structural Biology

Macromolecules, such as peptides and nucleic acids, underpin the key functions of all cells. Due to this, determining the exact structure and function of these molecules is of the utmost importance. Studying the ways in which proteins fold (tertiary structure) and combine (quaternary structure) has led to the development of treatments for complex diseases and genetic disorders.

## Information overload

In order to determine a macromolecular structure, structural biologists collect information from many sources both experimental and computational. Specialised software can be used to analyse specific components of this information but, at present, no tools exist that can integrate experimental and calculated data to produce new, testable hypotheses. Researchers at the University of Oxford have developed BiobOx, a fully integrated computational tool, which solves numerous problems in structural biology.

## Opening the lid on BiobOx

BiobOx allows the user to manipulate and analyse key quantities at all levels of macromolecular structure (primary to tertiary structure). BiobOx can exploit these structures as sub-units to propose highly complex quaternary structures. Structures generated in BiobOx can also be verified using experimentally obtained electron density maps.

We believe that the key advantages of BiobOx are:

- Fully integrated structural biology software solution
- Generates protein assemblies based on custom architecture
- Calculates collisional cross-sections based on the electron density map
- Assesses the amino-acid cross-linking distance as a solvent accessible path

## Commercialisation

BiobOx is currently available free for academic users. Oxford University Innovation Ltd is also seeking commercial licensees for BiobOx.

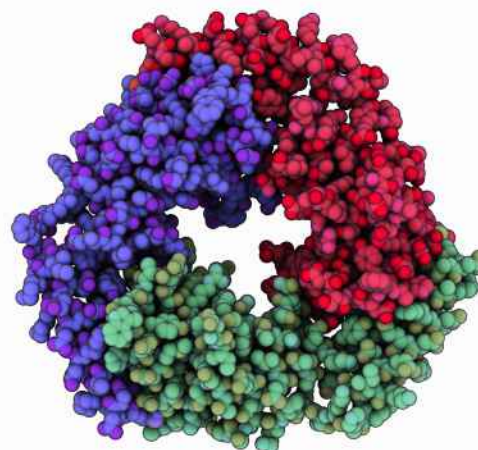

**For further information please contact:**  
**Dr Richard Auburn**  
[richard.auburn@innovation.ox.ac.uk](mailto:richard.auburn@innovation.ox.ac.uk)  
**+44 (0)1865 280956**  
[www.innovation.ox.ac.uk](http://www.innovation.ox.ac.uk)  
**Project number: 13367**

## Technology Transfer from the University of Oxford

The information in this Project Profile is provided "as is" without conditions or warranties and Oxford University Innovation makes no representation and gives no warranty that it is the owner of the intellectual property rights in the technology described.



# Protein team assembly for controlling cell signalling and catalysis



**Available to license:** A simple method to link proteins into programmed chains via spontaneously reacting peptide/protein pairs, generating a new class of tools to manipulate cell behaviour.

Researchers at the University of Oxford have developed a 'bacterial superglue', known as SpyTag/SpyCatcher, from *Streptococcus pyogenes*.

## SnoopTag

Researchers at the University of Oxford recently developed a 'bacterial superglue', known as SpyTag/SpyCatcher, from *Streptococcus pyogenes*. They have now developed a new peptide/protein pair named SnoopTag/SnoopCatcher, from *Streptococcus pneumoniae*, which spontaneously locks together through a covalent bond. SnoopTag/SnoopCatcher reaction is high yielding and fast, while the bond can survive extreme pH, high ionic strength and detergents. SnoopTag/SnoopCatcher and SpyTag/SpyCatcher are genetically encodable and are mutually unreactive, so they allow many new opportunities for controlled and irreversible linkage of peptide and protein components. By exploiting these peptide/protein pairs together, a modular and high yielding approach to irreversibly assemble proteins into chains has been developed.

## Generating protein chains

Solid-phase synthesis, which involves reactants bound to resin, enabled a revolution in the generation of peptides and oligonucleotides to efficiently explore and control biological function. However, solid-phase linkage for proteins is much more complex because of the large number of potential reactive groups present. Previous methods only generated short protein chains because the methods give a range of undesired side-products, have weak linkages, or use non-genetically-encoded components.

The key properties of SnoopTag/SnoopCatcher-based solid-phase assembly are:

- Simple add-and-wash procedure
- Irreversible linkage
- Completely genetically encoded, with no use of alternative amino acids
- High specificity
- No need to purify intermediates

- Protein unit to be added modified only with two small peptide tags, which can be located at the N-terminus, C-terminus or an internal site on the protein
- No cysteines in the reaction, so applicable to proteins containing free cysteines or disulfide bonds

This approach enables combinatorial assembly of polyprotein teams and should open up a new area for controlling how protein components work together. Uses of this invention include vaccine generation, enzyme substrate channelling, antibody polymerisation, drugs for activating cell signalling and biomaterials.

## Current status

This technology is subject to a patent application. Isis is interested in hearing from potential partners who wish to develop the technology and explore the commercial opportunities.



### Typical cell surface ligands

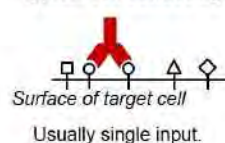

Usually single input.

### Polyprotein ligands



New class of molecule enabled by SpyTag and 2<sup>nd</sup> glue SnoopTag

Multiple inputs in precise arrangement. Maximize signal activation, minimize non-specific effects.

For further information please contact:

Dr Christine Whyte

[christine.whyte@innovation.ox.ac.uk](mailto:christine.whyte@innovation.ox.ac.uk)

+44 (0)1865 280921

[www.innovation.ox.ac.uk](http://www.innovation.ox.ac.uk)

Project number: 12370

## Technology Transfer from the University of Oxford

The information in this Project Profile is provided "as is" without conditions or warranties and Oxford University Innovation makes no representation and gives no warranty that it is the owner of the intellectual property rights in the technology described.

# SpyTag and SpyCatcher version 2.0



Oxford researchers have improved SpyTag and SpyCatcher, a peptide/protein pair that acts as a 'superglue' for proteins.

## Peptide tags

Peptide tags are convenient tools for protein analysis and modification due to their small size, which reduces the chance of affecting protein functionality. The small interaction surface between a peptide and its associating protein partner results in a lack of affinity.

Protein engineers in Oxford have come up with a solution: adapting natural proteins forming covalent bonds to design stronger peptide tags. SpyTag and SpyCatcher are a peptide/protein pair adapted from the adhesins of *Streptococcus pyogenes* by a group of Oxford researchers.

## SpyTag and SpyCatcher Version 2.0

The same group has now designed SpyTag and SpyCatcher Version 2.0, which significantly improves on the performance of the previous technology while retaining all the benefits of their predecessors. They work across a wide range of experimental conditions (e.g. pH values, temperatures and buffers) even in the presence of detergent, show specificity in cellular systems and are also equally heat-resistant.

Version 2.0 exhibits a more than 10-fold increase in the speed of reaction, whilst self-reaction of SpyCatcher is impeded. This increase in reaction rate will be important in improving speed and sensitivity for capture of biological targets that are expressed at low concentrations.

## Uses of the technology

SpyTag and SpyCatcher Version 2.0 can be used for a myriad of purposes:

- Targeting fluorescent or other biophysical probes to specific proteins

- Protein immobilisation for proteomics
- Conjugation of antigens to virus-like particles, viruses, bacteria or multimerisation scaffolds for vaccination
- Increasing enzyme resilience by SpyRing cyclisation
- Linking multiple enzymes into pathways to promote metabolic efficiency
- Solid-phase polyprotein synthesis which can activate multiple signalling pathways

## Commercialisation

This technology is subject to a patent application. Oxford University Innovation would like to speak to companies who are interested in licensing the technology.

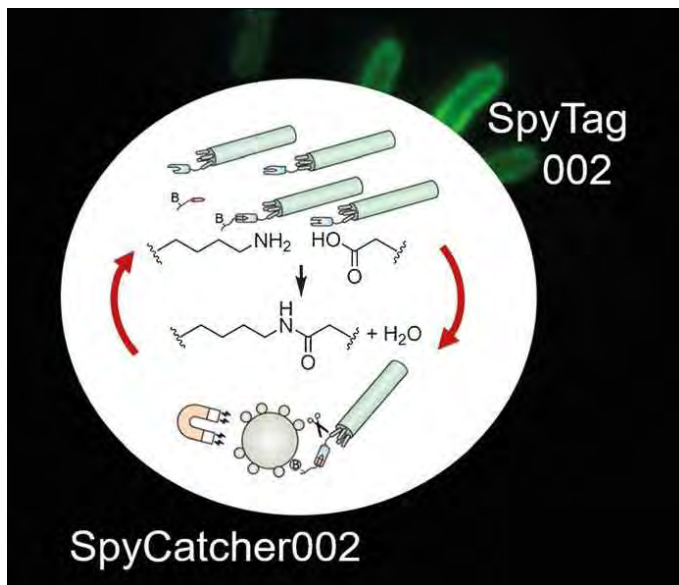

For further information please contact:

**Dr Christine Whyte**

[christine.whyte@innovation.ox.ac.uk](mailto:christine.whyte@innovation.ox.ac.uk)

+44 (0)1865 280921

[www.innovation.ox.ac.uk](http://www.innovation.ox.ac.uk)

Project number: 14348

## Technology Transfer from the University of Oxford

The information in this Project Profile is provided "as is" without conditions or warranties and Oxford University Innovation makes no representation and gives no warranty that it is the owner of the intellectual property rights in the technology described.

# SnoopLigase for catalysis of ligation between two peptide tags



Oxford researchers have developed a tool that greatly enhances the functionality and diversifies the use of the current SpyTag/SpyCatcher peptide technology.

## Tag/Catcher systems

SpyTag/SpyCatcher and SnoopTag/SnoopCatcher are powerful bioconjugation tools developed by Oxford researchers by exploiting the natural properties of *Streptococcus pyogenes* and *S. pneumoniae*. The Tags and Catchers act as 'superglue' for proteins – spontaneously forming irreversible isopeptide bonds with each other when combined.

The Tag/Catcher technologies are currently used by researchers worldwide. The functionality of the tools is, however, limited by the size of the Catcher – the partner protein for the corresponding Tag peptide. For example, the Catchers need to be fused at the termini of proteins to prevent protein folding interferences. Moreover, when the Tag/Catcher systems are used for vaccine optimisation, the induction of antibodies or T cells may be directed towards the Catcher rather than the target antigen.

## SnoopLigase

The same Oxford research group have solved the problem by developing SnoopLigase. SnoopLigase catalyses the irreversible conjugation between SnoopTag and a novel peptide (known as DogTag). The functionality of SnoopLigase is much better than its predecessor, SpyLigase, with the following improvements:

- Coupling efficiency is much higher (95% vs. 50%)
- Speed of reaction is increased by 6-fold (4 hours vs. 24 hours)
- Works at 25°C and 37°C (while SpyLigase only works at 4°C)
- Works across a broader range of buffers

This invention maximises the potential of the Tag/Catcher system and provides a great deal of flexibility to experimental design and uses. For instance, SnoopLigase can be used for biomaterial construction and conferred exceptional heat resilience when cyclising different enzymes, on top of all the applications of the Tag/Catcher system including:

- Fluorescent or biophysical probe tagging of specific proteins
- Protein immobilisation for proteomics
- Linking multiple enzymes into pathways to promote metabolic efficiency.

## Commercialisation

This technology is subject to patent application. Oxford University Innovation would like to speak to companies who are interested in licensing this technology.

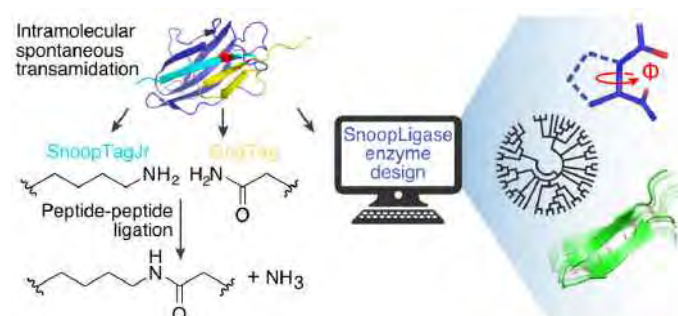

**For further information please contact:**  
**Dr Christine Whyte**  
[christine.whyte@innovation.ox.ac.uk](mailto:christine.whyte@innovation.ox.ac.uk)  
**+44 (0)1865 280921**  
[www.innovation.ox.ac.uk](http://www.innovation.ox.ac.uk)  
**Project number: 14383**

## Technology Transfer from the University of Oxford

The information in this Project Profile is provided "as is" without conditions or warranties and Oxford University Innovation makes no representation and gives no warranty that it is the owner of the intellectual property rights in the technology described.

# Electrochemical oxidase test for identifying and quantifying bacteria



Oxford researchers have transferred the oxidase test to an electrochemical set-up for accurate quantification and detection of bacteria in biological samples.



The global microbial identification market is expected to reach \$3 billion by 2022. This includes pathogen detection, human disease diagnosis, pharmaceuticals and food and beverage safety. Rapid and cost-effective methods for measuring bacteria are vital for these industries.

## Detecting oxidase-positive bacteria

The oxidase test is a well-known method for detecting bacteria that produce cytochrome C oxidase. The test reagent, N,N,N',N'-tetramethyl-para-phenylene-diamine (TMPD), turns blue in the presence of oxidase-positive bacteria and can therefore be used to detect the presence of certain pathogens.

Researchers at the University of Oxford have developed an electrochemical method of deploying TMPD for the detection of oxidase-positive bacteria, an important improvement to the colorimetric test.

The electrochemical oxidase test can be used for detection and quantification of bacteria in biological samples. It offers an accurate, fast and inexpensive analysis method for pathogenic and non-pathogenic bacteria.

The Oxford Researchers have demonstrated for the first time that cytochrome c oxidase expression can be measured in aerobically grown E. coli, which is currently not possible using any other method. The technique can be applied to a range of pathogenic bacteria and can be used in biosensing technology.

**For further information please contact:**

**Dr Jamie Ferguson**  
[jamie.ferguson@innovation.ox.ac.uk](mailto:jamie.ferguson@innovation.ox.ac.uk)  
**+44 (0)1865 280851**  
[www.innovation.ox.ac.uk](http://www.innovation.ox.ac.uk)  
**Project number: 15033**

## Technology Transfer from the University of Oxford

The information in this Project Profile is provided "as is" without conditions or warranties and Oxford University Innovation makes no representation and gives no warranty that it is the owner of the intellectual property rights in the technology described.

# Rapid detection of developed viruses and lipid-coated nanoparticles



Researchers at the University of Oxford have developed a new approach for labelling lipid-coated nanoparticles, such as enveloped viruses, for their rapid detection, quantification and isolation.

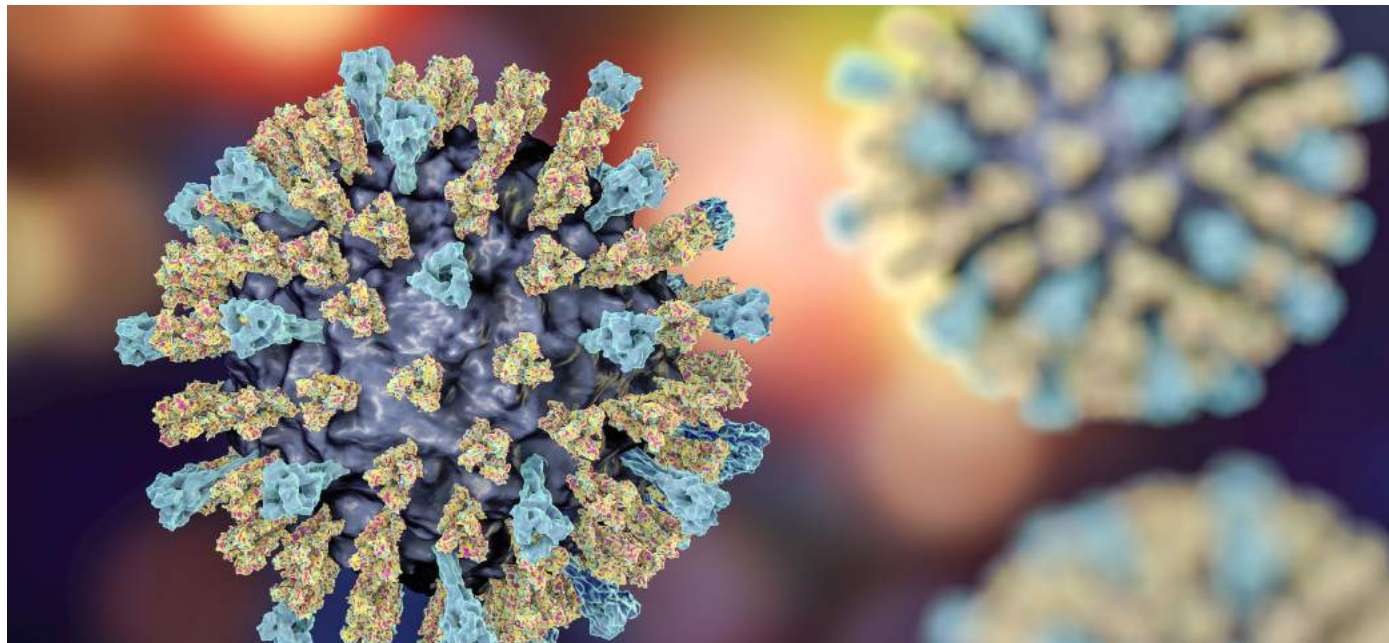

Traditional approaches for virus detection and quantification, such as cell culture and antigen-based tests, are often limited by long waiting times or limited sensitivity and specificity.

## Enhancing rapid detection of viruses

Oxford University researchers have invented a novel approach for labelling lipid-coated nanoparticles, such as enveloped viruses, exosomes or synthetic lipid vesicles. This method uses calcium ions to mediate an interaction between the surface of the lipid particle and DNA. The DNA can be modified with fluorophores for rapid optical detection of the particles, or can include a functionalised group for particle pull-down using affinity purification.

Using enveloped viruses as an example, the researchers used calcium-mediated labelling combined with single-particle tracking to rapidly and sensitively detect and quantify virus particles. Fluorescently labelling viruses using this method has resulted in very bright virus particles, seen using light microscopy. The inventors have successfully combined the labelling technique with a downstream assay for detecting specific virus strains. These methods have been proven effective on several types of enveloped viruses, including both influenza A and B subtypes, respiratory syncytial virus (RSV) and baculovirus.

The inventors have used this approach to detect clinical isolates of influenza, which could be directly detected within just 1 minute, making the assay significantly faster than currently available antigen-based tests. The method is simple, efficient, reversible and rapid, and represents a powerful technique with applications in viral diagnosis, vaccine production and research. The technique does not require bespoke equipment and allows direct detection of virus particles, thereby requiring only a small sample volume and no amplification or purification steps.

The inventors have also shown that it is possible to label small synthetic lipid particles in a similar manner. The method is therefore general, and can be used with a wide variety of viruses, particles, and modifying groups. The inventors are currently working on ways to combine the calcium-labelling approach with specific labelling using fluorescently-labelled genome probes.

**For further information please contact:**  
**Iraida Soria Espinosa**  
[iraida.soriaespinosa@innovation.ox.ac.uk](mailto:iraida.soriaespinosa@innovation.ox.ac.uk)  
**+44 (0)1865 614453**  
[www.innovation.ox.ac.uk](http://www.innovation.ox.ac.uk)  
**Project number: 15681**

## Technology Transfer from the University of Oxford

The information in this Project Profile is provided "as is" without conditions or warranties and Oxford University Innovation makes no representation and gives no warranty that it is the owner of the intellectual property rights in the technology described.



SOFTWARE

# HTSense: Simplifying the analysis and design of high throughput screens



**Available to license:** A flexible method for visualising complex datasets and designing validation studies.

## High throughput screening

The advent of automated high throughput screening (HTS) has revolutionised drug discovery process. Lead compound identification has been streamlined as hundreds or thousands of reactions and interactions can be evaluated simultaneously. Due to its complex nature, HTS generates unprecedented amounts of data. The analysis of which requires specialist tools.

## Many experiments mean many tools

Scientists currently use a multitude of different tools for analysing the data produced from HTS experiments. Tools exist for specific experiments, such as siRNA pooling, which explores a single interaction. However, increasing the complexity of the system generally means that the existing tools lack sufficient flexibility to process the additional parameters that are required to make sense of such rich datasets.



## HTSense: Embracing complexity

Researchers at the University of Oxford have developed HTSense; a tool capable of analysing the data arising from highly complex HTS experiments. HTSense is able to normalise the results from a range of experiments and conditions. This allows for the biological data to be inspected in a different context that can include plate artefacts, systematic bias, compound/gene information, cell line/cancer profile and many others.

HTSense offers a number of benefits over the current data analysis tools:

- Accommodation of complex design
- Ability to reuse the data and analysis steps
- Allows for different normalisation and QC approaches
- Gives contextual data with respect to the existing knowledge landscape

## Ready for license

Oxford University Innovation is seeking commercial and non-commercial licensees for the HTSense software.

For further information please contact:  
**Dr Richard Auburn**  
[richard.auburn@innovation.ox.ac.uk](mailto:richard.auburn@innovation.ox.ac.uk)  
**+44 (0)1865 280956**  
[www.innovation.ox.ac.uk](http://www.innovation.ox.ac.uk)  
**Project number: 12350**

## Technology Transfer from the University of Oxford

The information in this Project Profile is provided "as is" without conditions or warranties and Oxford University Innovation makes no representation and gives no warranty that it is the owner of the intellectual property rights in the technology described.

# Quantiphyse - Improved analysis of biomedical imaging data



Researchers at the University of Oxford have developed a tool to accurately view and analyse biomedical imaging data.

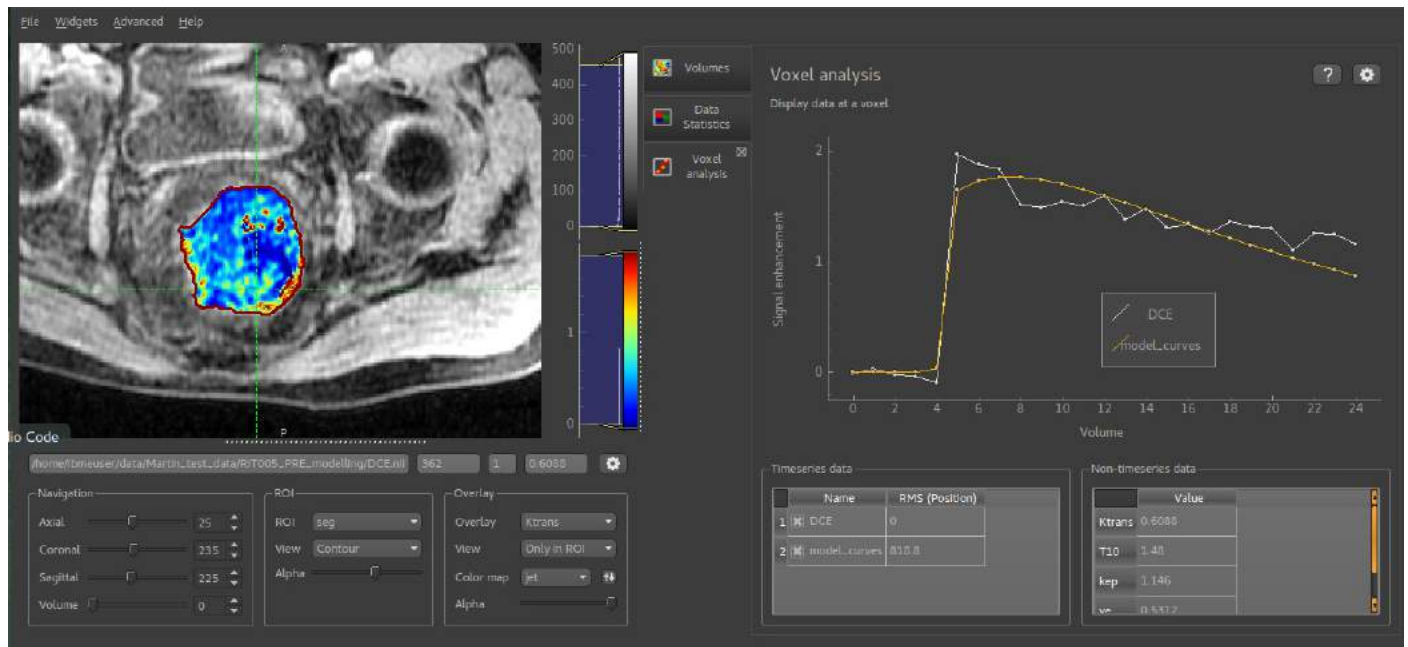

Over the years, medical imaging techniques have undergone major advances. The most common types of imaging include X-rays, ultrasound, CT scans and MRI.

Quantiphyse is an advanced visual tool for 3D and 4D (time) biomedical imaging data. It is particularly suited for physiological or functional imaging data comprised of multi volumes in a time series and /or multimodal imaging data. Applications of the software tool include highlighting features in the brain and cancerous growths associated with the underlying physiology.

The software is capable of generating spatially resolved measurements of physical or physiological processes from imaging data using either model-based or model-free methods. It relies, in large part, on exploiting Bayesian inference techniques.

Quantiphyse can analyse data both voxelwise or within regions of interest that may be manually or automatically created, e.g. supervoxel or clustering methods.

## Key features include:

- 2D orthographic viewing and navigation of data, regions of interest (ROIs) and overlays
- Universal analysis tools including clustering, supervoxel generation and curve comparison
- Tools for CEST-MRI analysis and modelling
- Tools for DCE-MRI analysis and modelling
- Tools for ROI generation
- Registration and motion correction
- Extensible via plugins, in the future to include ASL MRI data, Bayesian modelling and more

Quantiphyse is now available directly through the [Oxford University Innovation Software Store](https://www.innovation.ox.ac.uk).

**For further information please contact:**

**Dr Chandra Ramanujan**

**chandra.ramanujan@innovation.ox.ac.uk**

**+44 (0)1865 614434**

**www.innovation.ox.ac.uk**

**Project number: 14419**

## Technology Transfer from the University of Oxford

The information in this Project Profile is provided "as is" without conditions or warranties and Oxford University Innovation makes no representation and gives no warranty that it is the owner of the intellectual property rights in the technology described.



# Motion sickness solution for electronic device use



Researchers at the University of Oxford have developed a new algorithm which obtains real-time movement data from vehicles and reduces the effects of travel sickness by moving content on the screen accordingly.

## Motion sickness

Motion sickness can occur while riding in most types of vehicle, and leads to symptoms ranging from discomfort and dizziness to nausea and vomiting in affected people. These effects make journeys highly uncomfortable for people who try to use their electronic portable devices while traveling.

Although some medications are available to prevent motion sickness (tablets and patches), healthcare services recommend you don't use electronic devices during journeys. Additionally, other types of products are commercialised, such as wristbands for acupuncture or mild electric shocks.

However, they are only effective for a limited portion of people, who need to remember to bring them whenever they wish to use portable electronic devices while travelling. Thus, there is a big need to develop other strategies to prevent this condition and allow people to use their devices without feeling sick.

## The Oxford solution

Based on this need, researchers at the University of Oxford have developed a new algorithm that can easily be implemented within an electronic device operation system without the user having to take medication etc. The algorithm takes multiple sensor inputs and moves the screen content according to the external movement of the vehicle. Settings can be personalized depending on the user's susceptibility to travel sickness and different settings can be defined, making the system suitable for most types of vehicles.

Advantages of this novel tool are:

- It can be implemented at operation system level
- It does not need to be linked to external apps
- It allows the user to customise the compensation
- It avoids motion sickness without the need for drugs or other therapies

## Commercialisation

This technology is subject to a patent application. Oxford University Innovation is actively looking for partners willing to develop and implement this novel technology. If your company could be interested, please do get in touch.



**For further information please contact:**  
**Dr Chandra Ramanujan**  
[chandra.ramanujan@innovation.ox.ac.uk](mailto:chandra.ramanujan@innovation.ox.ac.uk)  
**+44 (0)1865 614434**  
[www.innovation.ox.ac.uk](http://www.innovation.ox.ac.uk)  
**Project number: 14458**

## Technology Transfer from the University of Oxford

The information in this Project Profile is provided "as is" without conditions or warranties and Oxford University Innovation makes no representation and gives no warranty that it is the owner of the intellectual property rights in the technology described.

# Improved cross-linking models between amino acids with DynamXL software



Oxford researchers have developed software that can precisely model cross-links between amino acids in a protein by accounting for the dynamics of the linker and amino acid side chains.

## Structure matters

The growth of systems and structural biology has led to an increasing need to analyse more complex systems faster and accurately. Many diseases are consequences of altered functionality due to altered protein structures. A high-resolution protein structure can greatly improve our understanding of the operating mechanism of that protein and how alterations impact its functions. Furthermore, information about a protein structure can support the discovery and development of drugs that specifically target the protein.

## Vital insight

Chemical cross-linking coupled with mass spectrometry (XL-MS) is a revolutionary approach in structural biology that can help identify cross-links between amino acid side chains. It can provide vital insight into both the structure and organisation of proteins in a wide variety of conditions, including in solution. Existing algorithms that simulate cross-links for a given atomistic protein structure are highly error-prone. They fail to take important parameters, for example, the dynamics of amino acid side chains, into consideration.

## Dramatic increase in accuracy

Researchers at the University of Oxford have developed software that accounts for alternative orientations of the linker and amino acid side chains and large-scale protein conformational changes. The result is dramatically increased precision of protein structure models.

The software also:

- Outperforms existing approaches in interpreting XL-MS data
- Can be performed on an ensemble of alternative atomic arrangements

- Can deal with structural ensembles from various sources (NMR, X-ray crystallography and molecular dynamics etc.)
- Allows significant improvements in protein-protein docking
- Has been validated through exhaustive benchmarking
- Is capable of accommodating motions at both reactive side-chain levels and large-scale rearrangements of the protein backbone

This software represents a considerable increase in the obtainable structural insights attainable using chemical cross-linking.

## Commercialisation

Oxford University Innovation would like to hear from companies who may wish to license this software.

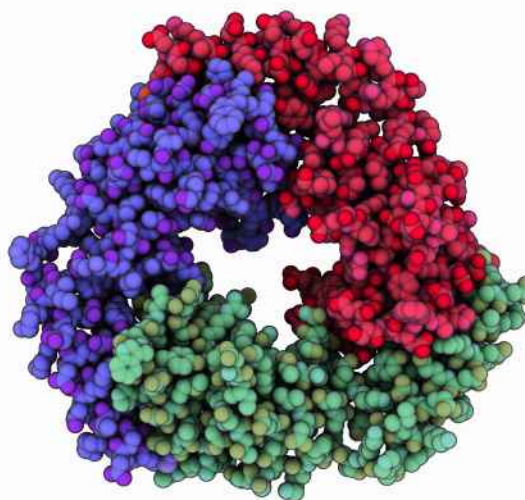

For further information please contact:

**Dr Richard Auburn**

[richard.auburn@innovation.ox.ac.uk](mailto:richard.auburn@innovation.ox.ac.uk)

+44 (0)1865 280956

[www.innovation.ox.ac.uk](http://www.innovation.ox.ac.uk)

Project number: 14605

## Technology Transfer from the University of Oxford

The information in this Project Profile is provided "as is" without conditions or warranties and Oxford University Innovation makes no representation and gives no warranty that it is the owner of the intellectual property rights in the technology described.

Researchers have developed a comprehensive toolkit that supports the acquisition, enrichment and application of structured semantic metadata.

## Metadata

Metadata can be defined as a computable representation of a large dataset's provenance and its intended interpretation. Metadata is used to make it easier to understand, more easily search and more consistently organise (or link) large datasets.

Whilst various types of metadata exist, semantic metadata is often viewed as the most comprehensive as it alone can identify connections and allows relationships to be drawn between fields. A semantic metadata methodology offers a more comprehensive view of a dataset.

## Manual data categorisation

Manual categorisation fails in comparison to automated methods because of human subjectivity preventing effective categorisation of all data into all appropriate groups. Manual methods not only increase errors but also risk increasing costs. Data is often incorrectly indexed, tagged or inefficiently organised which leads to reduced productivity.

## Semantic metadata toolkit

Oxford University researchers have developed a comprehensive toolkit for the acquisition, enrichment and application of structured semantic metadata from any dataset. This toolkit is particularly useful should the data come from a variety of sources. The nature of the software makes it suitable for management of data in any domain.

No existing commercial tool for the acquisition of metadata supports factorisation and extension, possibly inconsistent perspectives and versioning. This toolkit offers a high degree of automation in many respects, hence is suitable for use at scale.

## Supported functions include:

- Factorisation and extension of data specifications
- Collaboration between users with possibly inconsistent perspectives
- Automatic generation of specifications from data and software assets
- Semi-automatic enrichment and versioning of specifications
- Automatic generation or configuration of software
- Data discovery and data request management

## Commercialisation

This software is available to licence from Oxford University Innovation.

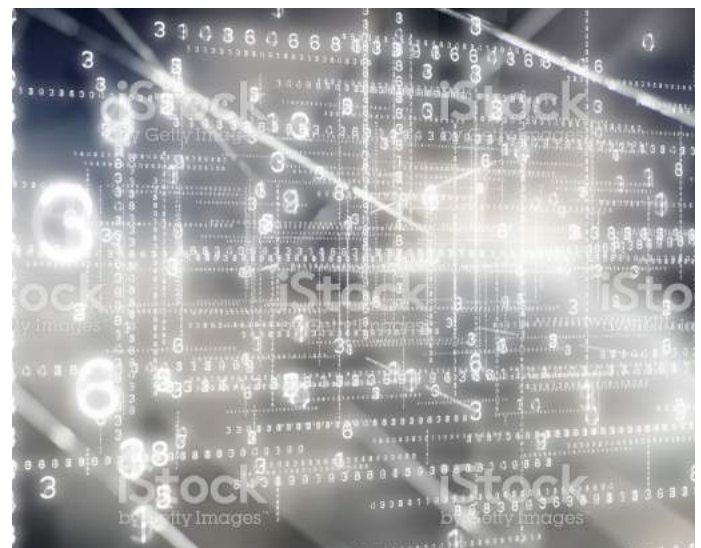

**For further information please contact:**  
**Dr Richard Auburn**  
[richard.auburn@innovation.ox.ac.uk](mailto:richard.auburn@innovation.ox.ac.uk)  
**+44 (0)1865 280956**  
[www.innovation.ox.ac.uk](http://www.innovation.ox.ac.uk)  
**Project number: 14761**

## Technology Transfer from the University of Oxford

The information in this Project Profile is provided "as is" without conditions or warranties and Oxford University Innovation makes no representation and gives no warranty that it is the owner of the intellectual property rights in the technology described.

# AFIRM: Amyloid Formation and Inhibition Mechanism



**Available to license:** Software for the determination of amyloid formation mechanism and how this is inhibited by the addition of drugs, using nuclear magnetic resonance (NMR) spectroscopy.

Oxford researchers have developed an efficient software platform and associated experimental protocols for the determination of a complete molecular amyloid formation mechanism, and how this is perturbed by the addition of small molecules, proteins and molecular chaperones.

## Amyloid mechanism

Many disorders including Alzheimer's and Parkinson's diseases are associated with amyloid formation and deposition in tissue. Improved understanding of the molecular mechanism of amyloid formation, and how this is perturbed by small molecules, proteins and chaperones is expected to support the discovery of diagnostic tests and therapeutics for such neurodegenerative diseases. Our method directly addresses this need.

## Platform for mechanism determination

Oxford University researchers have developed an approach for mechanism determination. NMR spectroscopy can quantitatively follow the specific changes in aggregating molecules without the need for the addition of, for example, fluorescent tags. This method functions in the context of heterogeneous non-equilibrium mixtures such as inside cells.

The approach provides experimental protocols for obtaining reproducible kinetic data, and globally analysing it to provide a molecular description of underlying events.

The AFIRM method has the following key features:

- Early events including the formation of primary nuclei can be identified and characterised.
- No normalisation of the data is required – this allows for a complete thermodynamic, as well as a kinetic description of the aggregation mechanism and inhibition mechanism.

- Method works in the presence of complex mixtures and in the presence of living cells.
- Software numerically efficiently evaluates rate equations allowing for exact testing of aggregation mechanisms of arbitrary complexity.

## Commercialisation

Oxford University Innovation is interested in speaking to companies that would like to use our facilities as a service or license this software for in-house use.

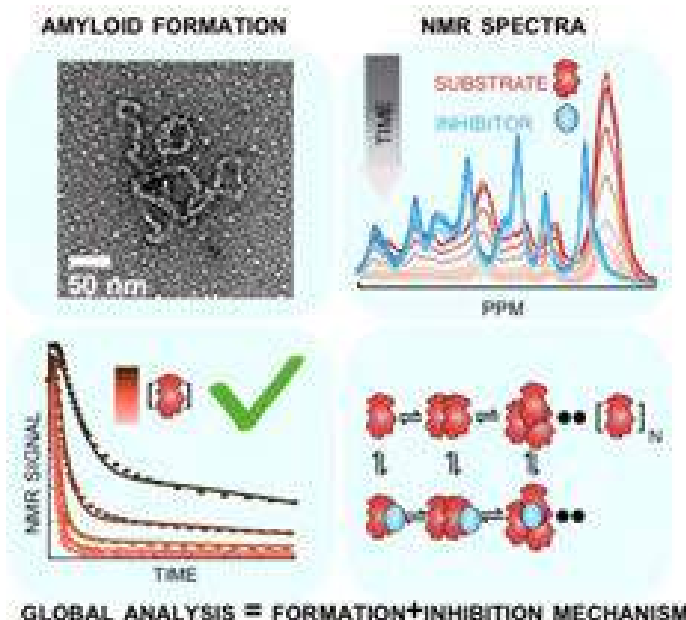

For further information please contact:

Dr Richard Auburn  
richard.auburn@innovation.ox.ac.uk  
+44 (0)1865 280956  
www.innovation.ox.ac.uk  
Project number: 14905

## Technology Transfer from the University of Oxford

The information in this Project Profile is provided "as is" without conditions or warranties and Oxford University Innovation makes no representation and gives no warranty that it is the owner of the intellectual property rights in the technology described.

Oxford researchers have developed user friendly software for *in silico* drug trials in populations of human cardiac cell models.

Evidence that drug safety and efficacy testing could one day be conducted by a computer rather than on animals has led a team at the University of Oxford to develop Virtual Assay software. The Virtual Assay software has the potential to replace thousands of *in vitro* animal experiments used globally each year for this purpose. A recent evaluation study on 62 reference compounds has predicted the risk that these drugs would cause abnormal heart rhythms in patients with 89% accuracy, while similar studies conducted in animals showed ~75-85% accuracy.

## Everyone is different

No two individuals respond to a drug in exactly the same way. Due to sometimes subtle variability at a physiological level, what works for one person may not work for another, even before taking into account any additional complicating factors. This is one of the most significant challenges faced by the pharmaceutical industry; clearly it is neither practical nor desirable to test a new drug on the entire population to ensure it is both safe and effective.

## Drug cardiac safety

Ensuring a drug does not have potentially harmful or unexpected side-effects for the heart is a top priority, and a rigorous testing phase is required before a drug can be approved for clinical use. Even then, unforeseen problems can occur due to the large variability in patient populations, exacerbation of other pre-existing diseases or interactions with other drugs. Early detection of potential side effects is crucial, since cardiotoxicity is one of the leading causes of drug failure during development, and it also accounts for about 45% of total post-approval drug withdrawal from the market.

## “Virtual” screening with Virtual Assay

To overcome this, *in silico* modelling is becoming increasingly important in pharmacology, for both drug efficacy and safety testing and is attracting significant attention from the commercial sector and regulatory

bodies such as the US FDA, UK MHRA, and the European MRA.

Virtual Assay also makes *in silico* drug trials in populations of human models accessible by non-experts in modelling and simulations, providing a user-friendly interface and a very efficient simulation engine (1 drug trials takes about 5 minutes for 100 cells using a modern PC).

## Key advantages:

- Human-based models, tightly coupled with experiments
- Populations of models to account for inter-cellular variability
- Quantitative prediction of the effects of drugs at the population level
- Mechanistic explanations into the causes of drug effects
- Consultancy services also available

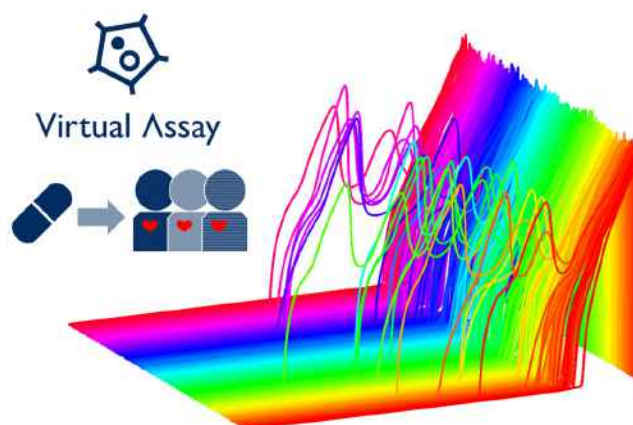

For further information please contact:  
**Sandeep Singh**  
[sandeep.singh@innovation.ox.ac.uk](mailto:sandeep.singh@innovation.ox.ac.uk)  
**+44 (0)1865 280907**  
[www.innovation.ox.ac.uk](http://www.innovation.ox.ac.uk)  
**Project number: 16245**

## Technology Transfer from the University of Oxford

The information in this Project Profile is provided "as is" without conditions or warranties and Oxford University Innovation makes no representation and gives no warranty that it is the owner of the intellectual property rights in the technology described.



# TARGETED THERAPIES

**Available to license:** Superior dendritic cells for immunotherapy

Cross-presenting dendritic cells derived from a patient's own skin cells promise to be the ideal starting point for the development of effective immunotherapies

## Dendritic cell-based immunotherapy

Dendritic cells are immune cells that play a key role in directing the body to recognise foreign antigens. Utilising dendritic cells to stimulate immune responses to specific antigens is a promising route to immunotherapy. Dendritic cells have been widely used for this purpose, but success of existing therapies has been limited due to the low 'cross-presenting' capacity of these cells that are generated from monocytes, a type of white blood cell.

A novel type of dendritic cell with superior abilities to 'cross-present' foreign antigens to immune cells has been recently found in mice and humans. These superior dendritic cells, identified by markers CD141 and XCR1, have only been found in very small populations insufficient to isolate numbers required for therapeutic development.

## Stem cells to dendritic cells

Led by Dr. Paul Fairchild, co-director of the Oxford Stem Cell Institute, Oxford researchers have developed a method to produce these dendritic cells from a patient's skin cells. The researchers took skin cells and turned them into 'induced pluripotent stem cells' (iPSCs) that can renew indefinitely and are capable of forming any cell type. The iPSCs were instructed to become dendritic cells using an approach that would be suitable for clinical use (no animal-based materials were used to aid growth).

Proof of principle that these superior dendritic cells are capable of modulating the immune system was demonstrated by using the cells to stimulate naïve T-cells and elicit a tumour specific immune response.

## Key benefits of technology

- Ability to induce specific response from naïve T cells
- Potential to scale-up for therapeutic development
- No animal-based materials used compliant with clinical application

## Intellectual property

US and European patent applications have been filed claiming the cross presenting cells and methods for producing them. Oxford University Innovation would like to speak to companies interested in licensing this technology for further development.

## References

Silk KM et al., (2011) Gene Therapy DOI:10.1038/gt.2011.177

<http://www.bbc.co.uk/news/health-15659972>

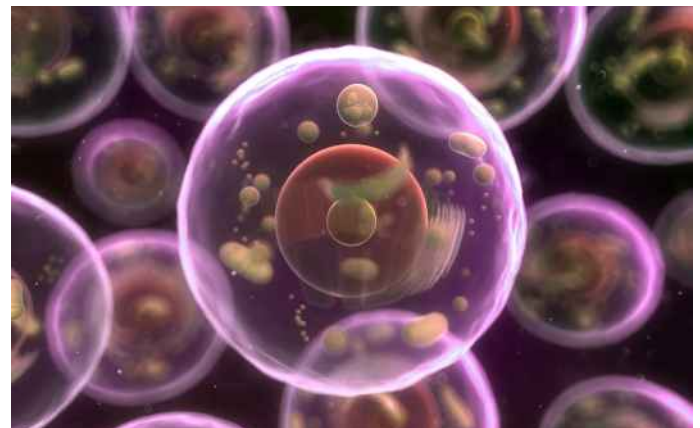

**For further information please contact:**  
**Dr Richard Reschen**  
[richard.reschen@innovation.ox.ac.uk](mailto:richard.reschen@innovation.ox.ac.uk)  
**+44 (0)1865 280872**  
[www.innovation.ox.ac.uk](http://www.innovation.ox.ac.uk)  
**Project number: 7381**

## Technology Transfer from the University of Oxford

The information in this Project Profile is provided "as is" without conditions or warranties and Oxford University Innovation makes no representation and gives no warranty that it is the owner of the intellectual property rights in the technology described.

Non-toxic carbohydrate based inhibitors of the protective capsule formation in pathogenic gram-negative bacteria, for use as antibacterial agents.

Antibiotic resistance is a serious and growing threat in contemporary medicine, emerging as one of the pre-eminent public health concerns of the 21st century. Some 125,000 people across Europe and the USA die every year due to bacterial infections resistant to antibiotic treatments. Within these regions, drug-resistant bacteria inflict an additional financial burden on healthcare systems through exaggerated medical costs of up to \$35 billion. Despite this looming crisis, the pharmaceutical industry has been slow to develop new antibiotics, with the pipeline of future treatments described by the World Health Organisation as “virtually dry”.

## Cell wall disruption

Oxford researchers have explored a new approach for treating infections caused by gram-negative bacteria, based on non-toxic carbohydrate drug candidates. A class of inhibitors has been identified that weaken bacteria by specifically damaging their outer cell wall, making them vulnerable to attack by the host’s own immune system.

The lead drug candidates have been shown to act at the outer membrane of bacteria from the extracellular environment without entering the cell. This allows a greater diversity of chemical functionalities of the candidates without necessarily following the general rules for properties of existing antibiotics.

## Advantages vs traditional treatments

- Non-toxic to probiotics within the host
- Accessible to targets located on the outer membrane of bacteria (no cell penetration)
- Specific to the transporter of the outermost protective layer of gramnegative bacteria (novel target)
- Effective as a potentiator of the host’s anti-bacterial immune system

This novel mode of action, general target protein family and greater structural latitude provide clear strategic advantages and dramatically decrease the possibility of acquired resistance. Compounds with similar structures to the Oxford blockers are stable and safe in humans, making the carbohydrate based leads very promising drug candidates.

## Additional applications

The Oxford compounds are not only active as anti-bacterial agents in therapeutic treatments. It is also possible for them to be incorporated into cleaning agents, deodorisers, sportswear and wound dressings.

## Licensing opportunity

The underlying technology is the subject of a PCT patent application and Oxford University Innovation welcomes contact from parties interested in developing this opportunity.

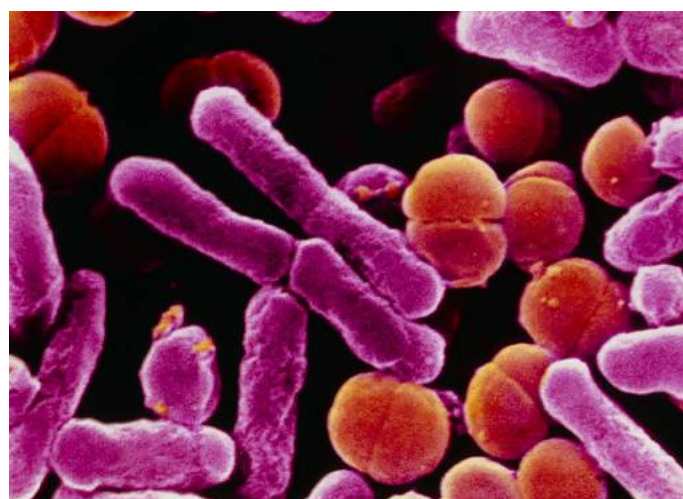

For further information please contact:  
**Andrew Bowen**  
[Andrew.Bowen@innovation.ox.ac.uk](mailto:Andrew.Bowen@innovation.ox.ac.uk)  
**+44 (0)1865 614449**  
[www.innovation.ox.ac.uk](http://www.innovation.ox.ac.uk)  
**Project number: 7876**



# Dendritic cells from induced pluripotent stem cells with an adult phenotype for immunotherapy



Oxford researchers have developed a method of producing dendritic cells from iPS cells displaying a mature 'adult phenotype', substantially increasing their potential effectiveness in immunotherapy

## Dendritic cells

Dendritic cells (DCs) are antigen presenting cells of the mammalian immune system which directly trigger and control responses by T cells. The use of DCs to prime responses to tumour-associated antigens (TAAs) represents a promising approach to cancer immunotherapy, however, clinically relevant responses have often been disappointing. Although these failures are partly due to the properties of the DCs most commonly used, obtaining sufficient quantities of more suitable DCs has proven difficult.

## Fetal phenotypes

Existing methods for obtaining scalable quantities of suitable DCs involve their production from induced pluripotent stem cells (iPSCs) or embryonic stem cells (ESCs). However, all cell types differentiated from ESCs and iPSCs display a primitive 'fetal' or 'neonatal' phenotype which may limit their therapeutic utility.

DCs derived from iPSCs and ESCs display a similar fetal phenotype which results in limited immunogenicity and increased tolerogenicity.

## All grown up

Oxford researchers have developed a simple method of generating DCs which display a mature 'adult' phenotype through an exploitation of the epigenetic memory that iPS cells possess for the cell type from which they were derived. DCs derived using this approach combine all the functionality of primary DCs with the many advantages of being derived from a pluripotent source. These advantages include the ability to scale-up procedures, tractability for genome editing and availability of otherwise inaccessible subsets of DCs with desirable properties.

DCs displaying an adult phenotype are suitable for applications in a variety of indications, including cancer immunotherapy, vaccination against chronic infectious microorganisms, and the induction of tolerance to defined protein antigens.

## Commercialisation

The method, intermediates, and product DCs are the subject of a patent application with scope for international coverage.

Oxford University Innovation is seeking external partners to support the commercialisation of the technology.

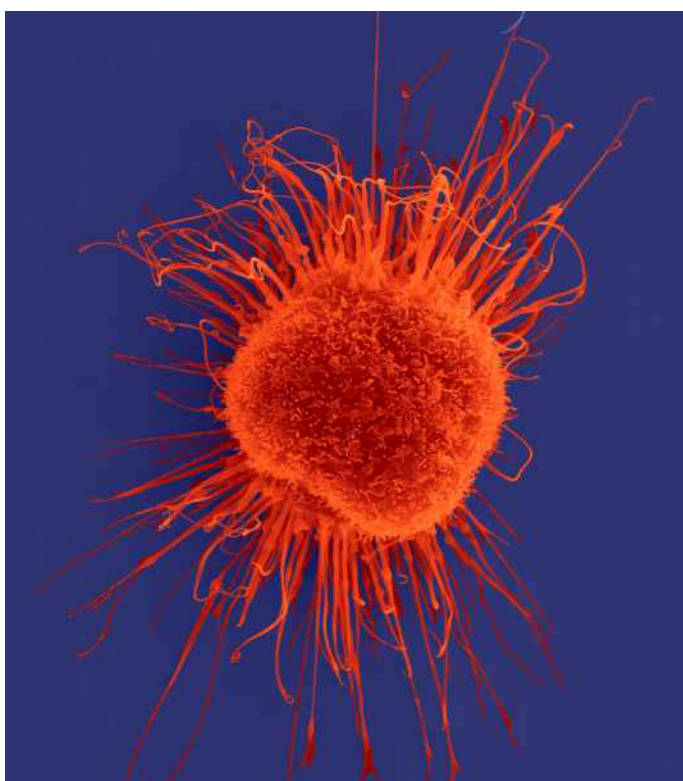

For further information please contact:

Dr Richard Reschen

[richard.reschen@innovation.ox.ac.uk](mailto:richard.reschen@innovation.ox.ac.uk)

+44 (0)1865 280872

[www.innovation.ox.ac.uk](http://www.innovation.ox.ac.uk)

Project number: 13048

## Technology Transfer from the University of Oxford

The information in this Project Profile is provided "as is" without conditions or warranties and Oxford University Innovation makes no representation and gives no warranty that it is the owner of the intellectual property rights in the technology described.

# A method for precisely tuning gene expression levels in mammalian cells



Researchers at the University of Oxford have developed a method for modulating gene expression in response to effector microRNAs.

## Manipulating gene expression

The fascinating cellular diversification characteristic of metazoans relies on a milieu of sophisticated regulatory systems, which act to control gene expression with minute spatial-temporal precision. Errors in these programs can have serious developmental consequences and lead to the onset of numerous human diseases.

Currently, studies aiming to understand the role of gene-products in various biological processes or to engineer cells for therapeutic purposes have relied on gene knock-ins (KI), knock-outs (KO) and RNA interference (RNAi). However, they are not suitable for studying or engineering quantitative changes in expression levels. Therefore, there is a need to develop methods for precisely tuning gene expression in mammalian cells.

## Cancer immunotherapy

The co-inhibitory receptor *programmed cell death 1* (PD-1) plays a central role in the ability of tumours to cause T-cell exhaustion and escape immune surveillance. Checkpoint blockade therapies that suppress PD-1 signalling can improve the anti-tumour response but also unleash severe autoimmune reactions. PD-1 KO has equally detrimental effects and can, paradoxically, lead to increased exhaustion and impaired survival of T-cells via the compensatory up-regulation of other co-inhibitory receptors. Therefore, precise, stepwise and context-dependent regulation of co-inhibitory receptors expression could help realise the promise of T-cell engineering for next-generation cancer immunotherapies.

## A new paradigm to precisely modulate gene expression

Researchers at Oxford have developed a new platform to precisely modulate gene expression that is applicable to a wide range of therapeutic applications. This approach relies on the engineering of synthetic microRNA response elements (MREs), which can harness the repressive potential of endogenous microRNAs to control the levels

of user-defined target genes. By introducing defined mismatches in these synthetic MREs the team was able to tune the strength of endogenous miRNA-mediated repression and consequently gene expression output to within 0.02% of any desired level. This strategy could provide an ideal solution for preventing tumor-induced exhaustion of engineered T-cells while mitigating the risk of autoimmune reactions.

## Benefits of this method:

- Intergration into existing manufacturing protocols for engineered T-cells;
- Precise tuning of gene expression;
- No exogenous interaction once the system is integrated into native genes or therapeutic transgenes;
- Reduced probability of off-target effects.

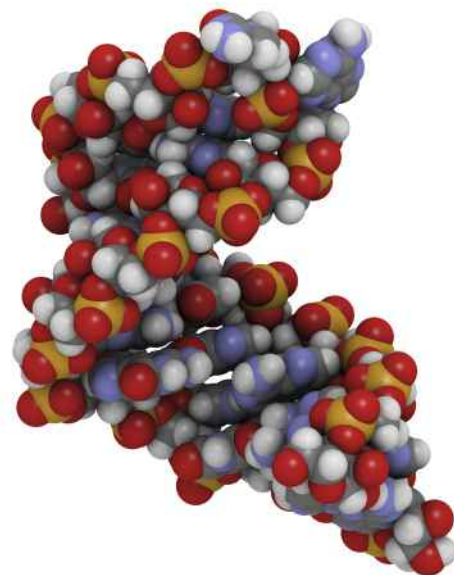

**For further information please contact:**  
**Dr Matthew Carpenter**  
[matthew.carpenter@innovation.ox.ac.uk](mailto:matthew.carpenter@innovation.ox.ac.uk)  
**+44 (0)1865 280970**  
[www.innovation.ox.ac.uk](http://www.innovation.ox.ac.uk)  
**Project number: 13338**

## Technology Transfer from the University of Oxford

The information in this Project Profile is provided "as is" without conditions or warranties and Oxford University Innovation makes no representation and gives no warranty that it is the owner of the intellectual property rights in the technology described.

# Inducible CRISPR-TR system for the conditional regulation of gene expression



Oxford researchers have developed an inducible CRISPR-based transcription regulator system that allows for spatiotemporal control of endogenous gene expression and assembly of gene circuits.

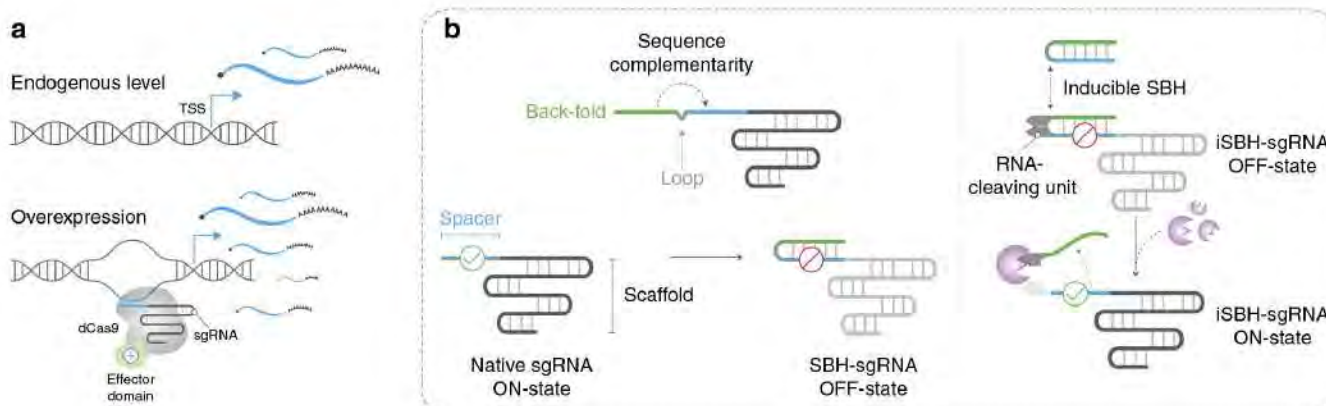

**Conditional control of CRISPR-TR activity by SBH-sgRNAs.** (a) Schematic representation of CRISPR-TR-based transcriptional modulation. (b) Conceptual framework underlying the design of inducible sgRNAs for the control of CRISPR-TR activity. Appending a back-fold extension to the 5' end of the native sgRNA promotes the formation of a spacer blocking hairpin (SBH) expected to switch the sgRNA to a quiescent state (OFF-state) (left). Replacing the basic loop with conditional RNA-cleaving units enables generation of inducible SBH designs (iSBH), which can restore CRISPR-TR activity in the presence of specific inducers (spacer release) (right).

## Current CRISPR-TR systems and their limitations

The CRISPR-based transcription regulator (CRISPR-TR) system was designed to control the output expression of any gene of interest. The system relies on a nuclease-deficient Cas9 fused with various effector domains, directed to specific genes by the single guide RNA (sgRNA). Chemically inducible or photo-activated CRISPR/Cas9 solutions are available but they require complex protein engineering and are difficult to scale up to implement synthetic networks across multiple genes.

## The Oxford inducible CRISPR-TR system

To address these limitations, Oxford researchers have developed an inducible CRISPR-TR system based on minimal engineering of the sgRNA. In this system, a spacer-blocking hairpin (SBH) structure is appended at the 5' end of the sgRNA to temporarily block CRISPR-TR activity. To conditionally enable the activity of Cas9, a range of inducible SBH (iSBH) modules were further developed, including proteins, small molecules as aptazyme and single-stranded DNA oligonucleotides. With the action of these molecules, the full repression of CRISPR-TF activity is annulled and can be controlled.

Compared to current methods, the system confers the following benefits:

- Simple, rapid and highly versatile
- Compatible with all Cas9 based applications
- Possible to encode a complete transcriptional programme in a single RNA molecule

- Facilitates the assembly of more complex gene circuits

As potential applications, the system can be used to:

- Answer fundamental biological questions involving precise spatiotemporal regulation of gene products
- Rewire cellular behaviour in basic research
- Develop smart therapeutics
- Create scalable gene circuits of interest such as orthogonal and parallel transcriptional programmes

As a proof of principle, the system has been used to assemble gene regulatory modules in human cells and the results are published in *Nature Communications*.

## Commercialisation

This technology is subject to a patent application. Oxford University Innovation is interested in hearing from companies that would like to license this technology.

Ferry et al, *Nature Communications* **8**, Article number: 14633 (2017)

doi:10.1038/ncomms14633

<https://www.nature.com/articles/ncomms14633>

**For further information please contact:**

**Dr Matthew Carpenter**  
[matthew.carpenter@innovation.ox.ac.uk](mailto:matthew.carpenter@innovation.ox.ac.uk)  
**+44 (0)1865 280970**  
[www.innovation.ox.ac.uk](http://www.innovation.ox.ac.uk)  
**Project number: 13916**

## Technology Transfer from the University of Oxford

The information in this Project Profile is provided "as is" without conditions or warranties and Oxford University Innovation makes no representation and gives no warranty that it is the owner of the intellectual property rights in the technology described.

# Synthetic Cas9-based programmable transmembrane receptors



Oxford University researchers have created a synthetic Cas9-based programmable transmembrane receptor system that enables a broad range of applications including conditional regulation of endogenous genes, conditional gene editing and implementation of complex transcriptional programs.

## Synthetic trans-activating receptors

Synthetic trans-activating receptors take advantage of the diverse signal transduction mechanisms in eukaryotic cells to achieve customisable sensing and response engineering. However, current synthetic trans-activating receptors are limited to the control of exogenous transgenes carrying specific enhancer elements. As a consequence, they are not suitable for user-defined control of endogenous gene expression.

## Cas9-based programmable transmembrane receptors

Oxford researchers have engineered a family of Cas9-based programmable transmembrane receptors that allows for conditional transcriptional regulation, conditional gene editing and rewiring of endogenous cellular pathways. This is achieved by combining an intracellular domain that consists of a proprietary engineered – dead or active – Cas9 molecule with a wide range of extracellular domains, such as synthetic GPCR, receptor tyrosine kinase, synNotch and others. Various inducers including small molecules, drugs, epitopes, viruses, lipids, sugars, cell-cell interactions etc. can be used to trigger the system depending on the nature of the chosen extracellular domain. This system can be used widely to reconfigure cellular pathways *in vitro* and *in vivo* for basic research and therapeutic applications.

Highlights of the receptor system:

- Programmable and versatile
- Enables user-defined control over when and where to regulate (activate/repress) the gene of interest
- Allows for dose-dependent control of gene expression
- Minimal OFF-state baseline activation and robust ON-state ligand-induced signal transduction
- Can easily implement parallel and orthogonal transcriptional programs by single guide RNA multiplexing

The system has been successfully tested for transcriptional activation of both a reporter construct and endogenous genes using programmable GPCR and RTK extracellular domains. Plans for the system to be tested in mouse models are in place.

## Commercialisation

This technology is subject to a patent application. Oxford University Innovation is interested in hearing from companies that would like to license this technology.

Baeumler, Ahmed & Fulga Engineering Synthetic Signalling Pathways with Programmable dCas9-based Chimeric Receptors, 2017, *Cell Reports* **20**, 2639 – 2653

<http://dx.doi.org/10.1016/j.celrep.2017.08.044>

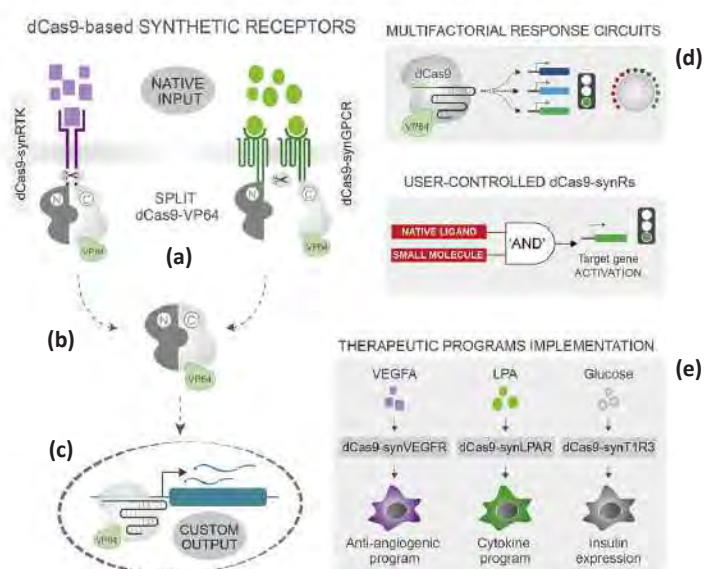

**dCas9-based SYNTHETIC RECEPTORS** (dCas9-synR) rely on a highly programmable, optimized split-dCas9 signal transduction module (a), which can be standardised across multiple classes of sensing domains. Ligand binding results in reconstitution of a functional dCas9-based transcription factor (b), enabling highly specific and robust activation of custom gene expression programs (c). Owing to their modular architecture, dCas9-synRs provide a powerful scaffold for the incorporation of user-controlled systems (safety switch mechanisms) (d). The unprecedented versatility of dCas9-synRs in redirecting cellular information flow makes them ideally suited for engineering designer cells capable of sensing specific disease markers and in turn driving custom therapeutic programs (e).

For further information please contact:  
[Technology@innovation.ox.ac.uk](mailto:Technology@innovation.ox.ac.uk)  
+44 (0)1865 280830  
[www.innovation.ox.ac.uk](http://www.innovation.ox.ac.uk)  
Project number: 13925

## Technology Transfer from the University of Oxford

The information in this Project Profile is provided "as is" without conditions or warranties and Oxford University Innovation makes no representation and gives no warranty that it is the owner of the intellectual property rights in the technology described.

Researchers at the University of Oxford have developed a control system that allows spatio-temporal activation of CRISPR, based on an engineered RNA guide strand.

## CRISPR/Cas9 approaches and limitations

CRISPR is described as “the technology of the century” and brings the hope of treatments for currently incurable diseases, by excising or silencing genes that drive tumour proliferation, repair of faulty genes, or by killing diseased cells.

However, unwanted DNA cuts, resulting from non-specific delivery to off-target cells, remain a serious problem in the successful clinical translation of CRISPR-based therapeutics. Exact spatio-temporal control of CRISPR/Cas9 activity would lead to the development of new therapies and new tools for biotechnology with great translational potential.

## Improvement on current methods with the Oxford technology

Oxford academics have developed an innovative control system allowing gene editing to be activated only in response to precisely defined combinations of biomolecular signals in targeted cell populations.

This technology is based on engineered Cas9 guide strands that incorporate sensor motifs that allow the nuclease Cas9 to cut DNA only when conditions characteristic of target cells are met. By improving the CRISPR/Cas9 constructs with the use of these modified guide-RNAs (gRNA) containing the blocking module, a nucleic-acid dependent activation of the Cas9 enzyme is allowed.

Furthermore, this unique design provides Cas9 sensing abilities with minimal leakage of activity, which is desirable for precise enzyme activity.

Several RNA guide strands have already been developed in the laboratory. Efficiency and selectivity of the system has been successfully tested *in vitro* and in cellular models.

## Main applications of conditional regulation

This new approach improves the current CRISPR/Cas9 gene editing applications and it can be applied to any gene regulation technique but with improved implementation and results:

- Use in biomedical applications for cell-type specific activation of the CRISPR/Cas9 system
- Tool for synthetic biology: genetic circuits or nucleic-acid nanotechnology
- Production of other conditionally activated CRISPR/Cas9 systems based on the use of other activation molecules, such as proteins or small molecules

## Commercialisation

This technology is subject to a patent application. Oxford University Innovation is interested in hearing from companies that would like to license this technology.

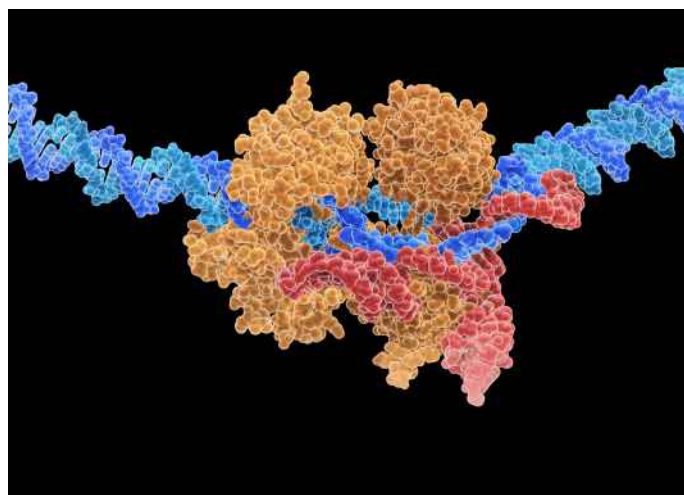

For further information please contact:  
**Bénédicte Menn**  
[benedicte.menn@innovation.ox.ac.uk](mailto:benedicte.menn@innovation.ox.ac.uk)  
**+44 (0)1865 280906**  
[www.innovation.ox.ac.uk](http://www.innovation.ox.ac.uk)  
**Project number: 14361**

## Technology Transfer from the University of Oxford

The information in this Project Profile is provided "as is" without conditions or warranties and Oxford University Innovation makes no representation and gives no warranty that it is the owner of the intellectual property rights in the technology described.



# VACCINES

# S-FLU: Broad spectrum flu protection with a superior safety and delivery profile



Oxford researchers have developed a novel live attenuated influenza virus vaccine that could be used safely in the face of a new pandemic strain of influenza, and for seasonal strains.

## Proactive pandemic prevention

An influenza pandemic remains a persistent threat to world health. While bespoke vaccines can be developed following the emergence of a novel strain, it would be a significant benefit to have a universal vaccine that could provide immunity across all influenza strains to proactively limit both pathology and viral transmission. While live vaccines represent the most effective approach to achieve this goal, they carry the inherent risk of transferring their genetic information to a circulating seasonal virus, which could render this strain highly virulent and inadvertently cause a pandemic.

## A live vaccine without the risks

S-FLU is a novel live attenuated influenza virus vaccine that has been engineered with the unique ability to provide broad T cell-based protection across type-A viruses, the constantly changing form of influenza responsible for both seasonal flu and the vast majority of epidemics.

## Key facts

- Suppression of haemagglutinin signal sequence expression enables infection without replication
- Generates a T-cell mediated immune response shown to protect mice and ferrets from a broad range of type-A influenza strains
- Efficacy comparable to FluMist®, the best-in-class licensed live attenuated influenza vaccine
- Risks associated with genetic transmission eliminated
- Optimal lung delivery is safe and feasible via small droplet aerosol
- Lower cost manufacture in mammalian cell lines

This novel approach to influenza vaccination represents a breakthrough in exploiting the enduring and broad spectrum benefits of live vaccination, yet without the serious risks of a full blown infection or viral gene transfer.

## Innovative vaccine opportunity and patent protection

It is envisaged that S-FLU will be of interest to companies wishing to strengthen their vaccination portfolio, or those looking to use S-FLU to enter the growing billion-dollar influenza therapeutics market.

Oxford University Innovation has filed a patent application, published as PCT/GB2012/052341, covering S-FLU, and would like to speak to companies interested in licensing this exciting technology.

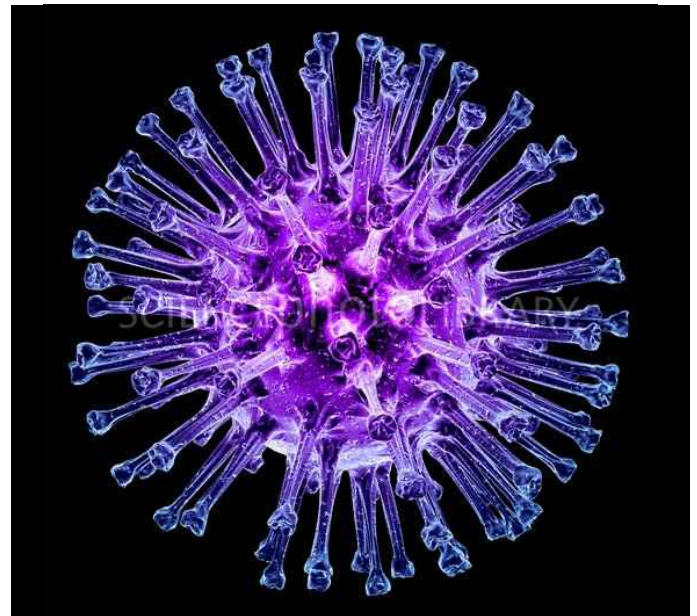

For further information please contact:

**Dr Matt Carpenter**

[matt.carpenter@innovation.ox.ac.uk](mailto:matt.carpenter@innovation.ox.ac.uk)

+44 (0)1865 280970

[www.innovation.ox.ac.uk](http://www.innovation.ox.ac.uk)

Project number: 7968

## Technology Transfer from the University of Oxford

The information in this Project Profile is provided "as is" without conditions or warranties and Isis Innovation makes no representation and gives no warranty that it is the owner of the intellectual property rights in the technology described.

# Hepatitis C Vaccine



Oxford researchers have developed a vaccine using the most conserved sequences of a Hepatitis C virus, including non-structural proteins.

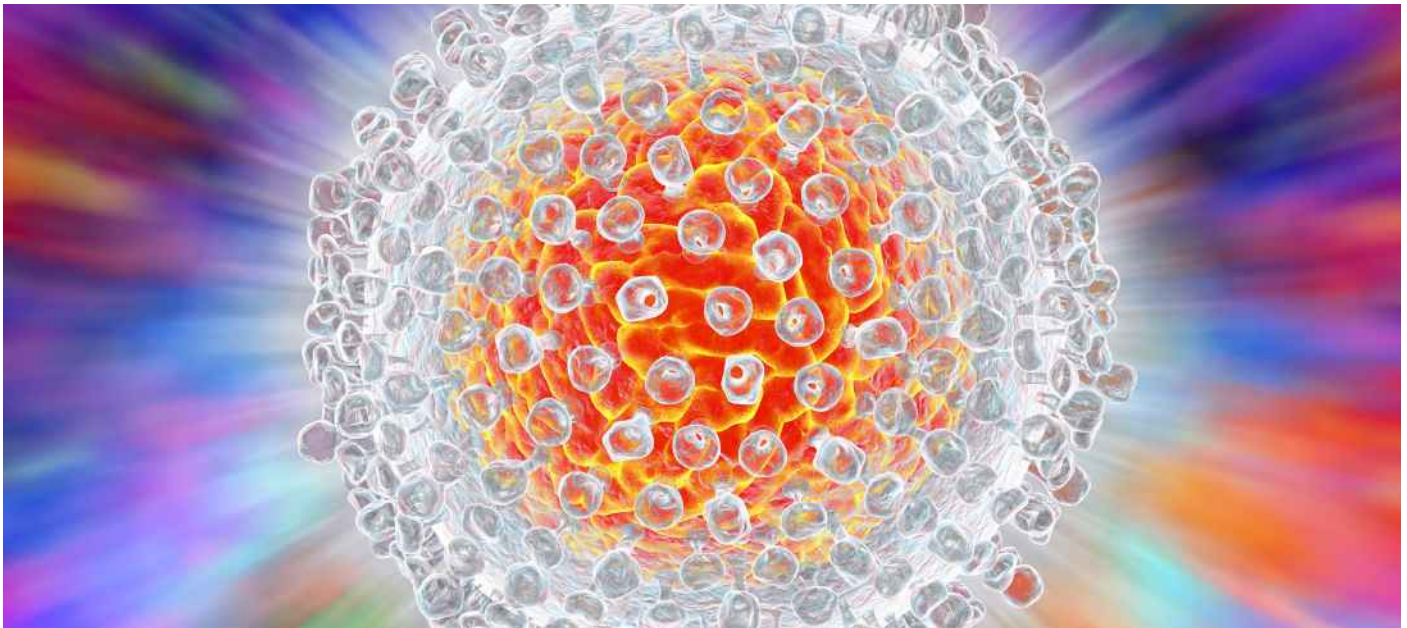

Hepatitis C virus (HCV) infection is a major global health concern - 170 million people are infected worldwide, with 3 – 4 million new infections annually. Many chronically infected patients develop complications of liver disease that include hepatocellular cancer, liver cirrhosis and liver failure.

Despite advances in HCV treatment, a prophylactic vaccine remains the most cost-effective and realistic means to significantly reduce the worldwide mortality and morbidity associated with persistent HCV infection.

A major challenge for HCV vaccine development is the significant viral diversity. However, parts of the viral genome are conserved, making these excellent targets in the context of a T cell vaccine. Hope for a vaccine for HCV lies in the fact that after primary infection spontaneous viral eradication occurs in a significant minority of patients, T cell immunity critically affects the clinical outcome.

The Jenner researchers have developed a HCV vaccine using non-replicating viral-vectored vaccines to induce T-cell responses against a single immunogen

incorporating the most conserved proteins of HCV, including non-structural proteins. The use of specially selected conserved viral segments from the non-structural proteins can provide protection against multiple HCV genotypes.

The HCV immunogen was designed using a software based approach to identify the most conserved and functionally critical protein sequences in all HCV genotypes. The researchers have developed a single immunogen that has been expressed in a simian adenoviral vector.

Immunogenicity trials of the HCV vaccine in mice have shown the induction of abundant T cells against the individual components of the antigen.

**For further information please contact:**  
**[technology@innovation.ox.ac.uk](mailto:technology@innovation.ox.ac.uk)**  
**+44 (0)1865 280830**  
**[www.innovation.ox.ac.uk](http://www.innovation.ox.ac.uk)**  
**Project number: 10355**

## Technology Transfer from the University of Oxford

The information in this Project Profile is provided "as is" without conditions or warranties and Oxford University Innovation makes no representation and gives no warranty that it is the owner of the intellectual property rights in the technology described.



**Available to license:** A series of chimeric immunogenic polypeptides capable of inducing robust, effective and cross-strain immunity to the Human Immunodeficiency Virus (HIV).

## Human Immunodeficiency Virus (HIV)

In 2015 it was estimated that 37.7 million people were living with HIV with the number of new infections estimated at 2.1 million. The disease resulted in 1.1 million deaths from AIDS-related illnesses. The development of new treatments for the disease is hampered by the genetic diversity of the virus.

## HIVconsv Protein

Delivered by simian adenovirus ChAdV63 and poxvirus MVA, the 1st-generation conserved vaccines were tested in 8 trials in UK, EU and Africa and showed high immunogenicity, replication control in vitro of 4 major HIV clades A, B, C and D and, in a pilot study in combination with early ART (antiretroviral therapy) and latency-reverting agent Romidepsin, produced a signal of viremic control during monitored ART pause in 36% of vaccine recipients. The vaccines with Vorinostat were also used in the first randomized blind 'kick and kill' trial RIVER.

## New developments

Learning from the trials, the researchers from Oxford and Los Alamos National Laboratory had an opportunity to upgrade the immunogens. The main improvements of the 2nd-generation tHIVconsvX include a bioinformatics-assisted redefinition of conserved regions, inclusion of protective & conserved epitopes and maximizing vaccine match to global HIV variants by bivalent mosaic design, while induction of responses against inter-regional junctions was minimized by a region scramble.

Administering the tHIVconsvX proteins as pairs using different vaccine modalities ensures a maximum match to global circulating HIV and the induction of effective, robust immunity.

The main benefits of this vaccine:

- Computer-optimised mosaic sequences designed to yield maximum HIV epitope match
- Effective and robust cytolytic T cells against the most vulnerable parts of the virus
- Could be used as part of a therapeutic or prophylactic vaccine

## Patent protection

Oxford University Innovation has filed a priority patent covering this project (WO2015048785A3 – Mosaic conserved region HIV immunogenic polypeptides) and is seeking partners to help commercialise the technology.

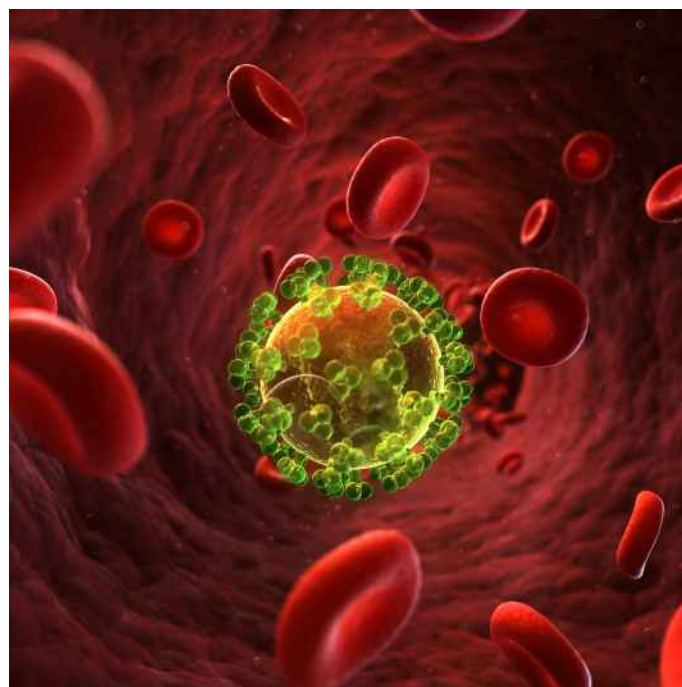

**For further information please contact:**

**Dr Matt Carpenter**

[matthew.carpenter@innovation.ox.ac.uk](mailto:matthew.carpenter@innovation.ox.ac.uk)

+44 (0)1865 280970

[www.innovation.ox.ac.uk](http://www.innovation.ox.ac.uk)

Project number: 10599

## Technology Transfer from the University of Oxford

The information in this Project Profile is provided "as is" without conditions or warranties and Oxford University Innovation makes no representation and gives no warranty that it is the owner of the intellectual property rights in the technology described.

# New class of molecular adjuvant



Oxford researchers have identified a family of enzymes that can increase immunogenicity towards a wide range of fused antigens.

## The adjuvant advantage

An adjuvant is a substance that is able to enhance or prolong the body's antigen-specific immune response to an administered vaccine. Simple inorganic aluminium salts, such as aluminium hydroxide or aluminium phosphate, have been commonly used as adjuvants since the 1930s. Recently, attention has turned to organic or biological adjuvants to tackle more challenging and complex disease targets.

## 4-Oxalocrotonate tautomerase (4-OT)

4-OT is an enzyme, which forms part of a key metabolic pathway in bacteria. The monomer unit contains just 62 amino-acid residues, making it one of the smallest known enzyme subunits; however, 4-OT forms a hexamer in solution. Researchers at the University of Oxford have been exploring the use of 4-OT proteins as vaccine adjuvants.

## Beating the superbugs

The group at Oxford have successfully fused a member of the 4-OT family (SAR1376) to a range of pathogen antigens from *Staphylococcus aureus* and *Plasmodium falciparum*. Following delivery of these fused complexes by DNA or viral vectors, increased immunogenicity has been observed *in vivo*. The 4-OT tag multimerises in solution and it is the aggregation that is thought to cause the observed increase in immunogenicity. This methodology represents a rare discovery of a non-human multimerisation domain that enhances immunogenicity when fused to a range of antigens.

Perhaps most importantly, 4-OTs are widespread in pathogenic bacteria (both Gram positive and Gram negative). Their conserved structure may allow this to be a generalised approach for enhancing antibody responses to vaccine antigens, offering an attractive alternative to virus like particles (VLPs).

We believe that the key advantages of this technology include:

- Adjuvant shows *in vivo* efficacy when fused to antigens from *S. aureus* or *P. falciparum*
- New platform technology for vaccine development
- Hundreds of potential adjuvants identified in diverse bacterial species
- Rare class of multimerisation tags that can enhance immunogenicity
- Fills need for more antigen scaffolding strategies

## Commercialisation

Oxford University Innovation Ltd. has filed a patent, which covers this work and is currently seeking a commercial partner to develop the technology.

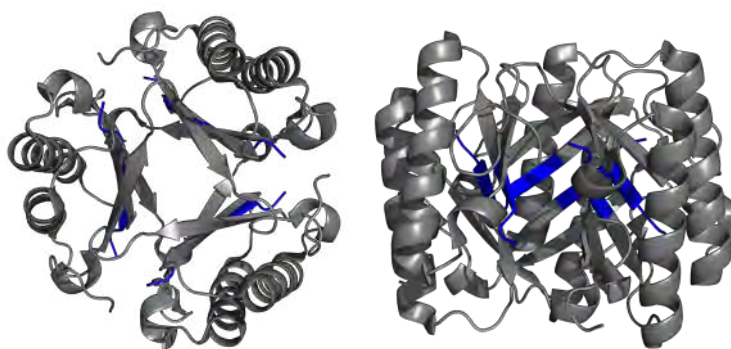

**Above image:** Crystal structure of the SAR1376 multimerizing protein, obtained from the Protein Data Bank

**For further information please contact:**  
**Dr Matthew Carpenter**  
[matthew.carpenter@innovation.ox.ac.uk](mailto:matthew.carpenter@innovation.ox.ac.uk)  
**+44 (0)1865 280970**  
[www.innovation.ox.ac.uk](http://www.innovation.ox.ac.uk)  
**Project number: 10924**

## Technology Transfer from the University of Oxford

The information in this Project Profile is provided "as is" without conditions or warranties and Oxford University Innovation makes no representation and gives no warranty that it is the owner of the intellectual property rights in the technology described.

# Multivalent Dengue Vaccine



**Available to license:** A universal Dengue vaccine to induce cellular immune responses against all dengue virus serotypes.

Dengue fever is the most rapidly spreading mosquito-borne viral disease in the world. The World Health Organisation estimates that almost half of the world's population lives in at-risk areas, with ~390 million new infections every year. The disease is caused by four dengue virus (DENV) serotypes, infection with one serotype only confers protection against re-infection with the same serotype. Multiple serotypes commonly circulate together in a particular geographical region and secondary infection with a different serotype carries the risk of developing haemorrhagic fever and shock due to antibody-dependent enhancement (ADE) where non-neutralising antibodies facilitate virus entry into host cells, leading to increased infectivity. Following infection with a secondary DENV serotype, the immune response can be skewed by the memory of the previous infection, with the titre of antibodies specific to the earlier virus being higher than for the currently infecting serotype; a phenomenon known as "antigenic sin".

A safe and effective DENV vaccine must induce strong, long-lived and equal protection against all four serotypes in order to avoid the risk of ADE or antigenic sin. Most DENV vaccines in development have been designed to induce protective antibodies against external proteins of each of the four virus serotypes and are formulated with components from each of the four serotypes.

An alternative approach has been pioneered at the University of Oxford's Jenner Institute. Researchers have



developed a vaccine to induce protective T-cell immunity against all four serotypes of DENV with minimal risk of inducing ADE or antigenic sin.

## Oxford Invention

The Jenner researchers have developed a DENV vaccine using non-replicating viral-vectored vaccines to induce T-cell responses against a single immunogen incorporating the most conserved non-structural DENV proteins. This vaccine has been designed to generate full protection against all DENV serotypes.

The vaccine was designed using a bioinformatics approach, to identify the most conserved and functionally critical protein sequences in all four serotypes of DENV, representative of the true global virus population. The researchers have developed a single immunogen comprising the most conserved segments of the internal NS3-NS5 genes across all four serotypes. This single, pan-serotype, universal dengue antigen has been expressed in a simian adenoviral vector and in the vector modified vaccinia Ankara, for use in a heterologous prime-boost vaccination regimen.

## Cellular Immune Response against all DENV serotypes

Immunogenicity trials of the DENV vaccine in mice have shown the induction of abundant T cells against all four serotypes represented in the novel dengue antigen, and studies in macaques show vaccine safety and immunogenicity.

The Jenner DENV vaccine is being currently evaluated in a DENV challenge model, which uses several strains of the virus which have been adapted to infect mice. In this model, induction of DENV-specific cytotoxic T-cells should prevent DENV infection in the mice.

For further information please contact:  
[technology@innovation.ox.ac.uk](mailto:technology@innovation.ox.ac.uk)  
[www.innovation.ox.ac.uk](http://www.innovation.ox.ac.uk)  
Project number: 11715

## Technology Transfer from the University of Oxford

The information in this Project Profile is provided "as is" without conditions or warranties and Oxford University Innovation makes no representation and gives no warranty that it is the owner of the intellectual property rights in the technology described.

# Staphylococcus aureus (*S. aureus*) vaccine



Researchers at the University of Oxford have identified two key proteins that could offer an alternative vaccine against *S. aureus*.

## Staphylococcus aureus - A resistant threat

The evolution of multi-drug resistant strains of *S. aureus* brings with it new challenges in treating the infections caused by these pathogens. It is likely that strains of *S. aureus*, which display resistance to our most potent antibiotics, will become more prevalent in the coming years. As *S. aureus* infections contracted during clinical procedures start to bypass our last line of defence, the clinicians will need to turn to alternative measures to halt the spread of these potentially deadly diseases.

## Prevention is the best cure

A viable option in the fight against drug resistant pathogens is prophylaxis. Although vaccines against *S. aureus* infections have entered clinical trials, they have resulted in high profile failures as late as stage III. Researchers at the University of Oxford have identified two antigens as new candidates for *S. aureus* vaccine development. The two Eap proteins in question are highly conserved homologues that are present in nearly all *S. aureus* studied.

## REap the benefits

All members of the Eap protein family interact with the innate immune response of the host to ensure the safety of the growing bacteria. Work at Oxford has shown immune neutralisation of the Eap protein family through vaccination could protect the host from *S. aureus* pathogenesis upon infection, and even prevent the organism establishing colonisation, a key step in *S. aureus* transmission. By generating vaccine antigens from Eap proteins, then delivering them using a non-replicating viral vector the immune system can be trained to attack these parts of the *S. aureus* pathogen.

We believe the benefits of this approach include:

- Vaccination offers a route to bypass drug resistance in pathogens
- Eap proteins are promising new vaccine candidates
- Early results indicate effectiveness in animal models
- Could be used in combination with other antigens
- Uniquely, suppresses establishment of colonisation

## Commercialisation

The technology discussed is covered by an International patent application PCT/GB2017/053301 (2 November 2017). Oxford University Innovation Ltd. is seeking a partner who could help take this promising vaccine lead to a clinical setting.



For further information please contact:  
**Dr Matthew Carpenter**  
[matthew.carpenter@innovation.ox.ac.uk](mailto:matthew.carpenter@innovation.ox.ac.uk)  
**+44 (0)1865 280970**  
[www.innovation.ox.ac.uk](http://www.innovation.ox.ac.uk)  
**Project number: 13619**

## Technology Transfer from the University of Oxford

The information in this Project Profile is provided "as is" without conditions or warranties and Oxford University Innovation makes no representation and gives no warranty that it is the owner of the intellectual property rights in the technology described.

# Zika viral vector vaccine



Oxford researchers have developed a Zika vaccine that can induce immune responses against the African and Asian lineages of the Zika virus.

## Zika virus

Zika virus (ZIKV) is a mosquito-borne virus that belongs to the family Flaviviridae. Initially detected in Africa, it has spread through Polynesia and is now spreading rapidly throughout the Americas and Asia. Since the outbreak of ZIKV disease in Brazil in 2015, ZIKV infection has been linked to neurologic conditions in developing foetuses, such as microcephaly and Guillain-Barre syndrome. Importantly, only 2 out of 5 people exhibit signs and symptoms of ZIKV infection, and person to person transmission makes ZIKV a very challenging flavivirus to tackle.

The virus has now spread to more than 45 countries, 25 of which reported severe ZIKV-associated disease. An estimated 100 million people in the Americas are predicted to be at risk of acquiring ZIKV. According to a recent WHO report, ZIKV remains an enduring public health challenge requiring intense action. There is an urgent need to protect women, either before or during pregnancy, from infection by the virus. Currently, there is no vaccine for ZIKV or effective treatment for the disease.

Designing an effective vaccine is highly challenging. When introduced with a viral vector, the antigen should be produced and secreted at an amount that is sufficient to stimulate robust antibody and cytotoxic responses. Ideally, the antigen should also induce an immune response against many (or all) strains of the virus.

## Zika viral vector vaccine

Oxford researchers have developed a Zika vaccine based on a viral vector which contains a sequence encoding a ZIKV structural antigen. Using a bioinformatic approach, the antigen consensus sequence that has been carefully

designed using the published ZIKV genetic sequences. It is highly similar - at least 99% - to the strains causing the epidemics in the Americas but also matches closely with the African genotype. The ZIKV antigen has been designed to allow high titers of antibody production after a single and non-adjuvanted vaccination dose. Therefore, the vaccine should be suitable to be used in many countries affected by various strains of ZIKV.

The vaccine induced a substantial immune response against ZIKV after a single dose with high levels of ZIKV antibodies up to 9 months after a single ChAdOx1 Zika vaccination, in mice.

## Available for licensing

A patent has been filed for this technology. Oxford University Innovation is seeking a development partner to license this technology and support its future developments.

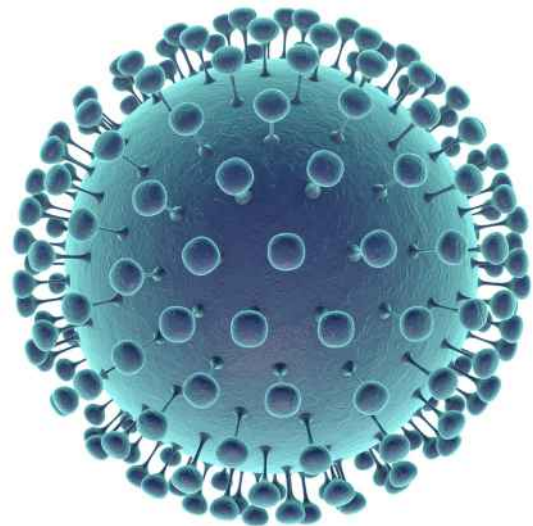

**For further information please contact:**  
**Dr Christine Whyte**  
[christine.whyte@innovation.ox.ac.uk](mailto:christine.whyte@innovation.ox.ac.uk)  
**+44 (0)1865 280921**  
[www.innovation.ox.ac.uk](http://www.innovation.ox.ac.uk)  
**Project number: 13769**

## Technology Transfer from the University of Oxford

The information in this Project Profile is provided "as is" without conditions or warranties and Oxford University Innovation makes no representation and gives no warranty that it is the owner of the intellectual property rights in the technology described.



# COA - CLINICAL OUTCOME ASSESSMENT



# The Amyotrophic Lateral Sclerosis Assessment Questionnaire (ALSAQ)



Clinical Outcomes

Enhance your value proposition with the Patient Reported Outcome (PRO) measure for ALS: the ALSAQ-40 and ALSAQ-5

## Background

Differentiate your product through the use of the ALSAQ (Amyotrophic Lateral Sclerosis Assessment Questionnaire) to generate a value proposition that shows efficacy over and above that of clinical and safety measures. Created by world-renowned experts in health status measurement in Oxford's Department of Public Health, the ALSAQ is a disease-specific PRO validated for measuring subjective health status in ALS (also known as Lou Gehrig's Disease or Motor Neurone Disease).

### Enhance your competitive advantage

The use of PROs to measure intervention success is becoming increasingly common in studies concerning incurable conditions such as ALS where the desired outcome is to improve patient health status and ameliorate symptoms. The ALSAQ is highly sensitive to disease-related changes where generic scores are not, offering you the maximum chance of detecting health status change with your intervention. ALSAQ data can achieve the approval of additional label claims that directly target patients' needs, and supports your European Summary of Product Characteristics, so that practitioners understand the impact that your therapy has on patients' wellbeing.

## Development

All key ALS health status issues were captured by in-depth interviewing of ALS patients. Questionnaire items constructed from the interviews cover five discrete scales:

- physical mobility
- activities of daily living
- eating and drinking
- communication
- emotional reactions

The ALSAQ is highly responsive to intervention efficacy, regardless of the mechanism of action. Available in a 40 item (ALSAQ-40) or a short form five item (ALSAQ-5) version, the ALSAQ may be employed in surveys or clinical trials for ALS/MND patient groups. Rigorous testing has shown this PRO measure to:

- be exceedingly reliable, robust and sensitive to change
- be easy to complete, resulting in an excellent response rate
- be straightforward to interpret (answers are on the five point Likert scale)
- have high face, internal and construct validity.

## ALSAQ Users

The research, subsequent development and validation of the ALSAQ was supported by the UK's Motor Neurone Disease Association

## Apply to use

The ALSAQ is managed, as part of a wide portfolio of Patient Reported Outcome measures, by Clinical Outcomes; an activity within the University of Oxford's technology transfer company, Oxford University Innovation Ltd. For further information on how to apply please get in touch via:

healthoutcomes@innovation.ox.ac.uk

+44 (0) 1865 614480



The Coeliac Disease Assessment Questionnaire (CDAQ) is a 32-item, patient-reported outcome measure developed to investigate the health-related quality of life of people living with coeliac disease.

## Background

The CDAQ was developed by researchers within the Health Services Research Unit, part of the Nuffield Department of Population Health at the University of Oxford.

There are two existing disease-specific PROMs that assess quality of life in people with coeliac disease, the Celiac Disease Questionnaire (CDQ) and the Coeliac Disease Quality of Life Survey (CD-QOL). However, there are limitations in the development of both measures, including the derivation of items. The CDAQ has been developed according to current best practice guidelines. The measure can be used in a range of settings, including clinical trials and clinical practice.

## Development

### 1. Derivation of items

Qualitative interviews were conducted with 23 adults with coeliac disease. Variation was sought across participant's demographic and disease characteristics, particularly gender, age, and duration since diagnosis. Interview data was audio-recorded with the participant's consent and transcribed verbatim. Interview data was analysed thematically in NVivo9. Following analysis, 63 candidate items were developed.

### 2. Refinement of items

Experts, including health professionals and researchers, provided feedback on candidate items via individual interviews and an expert panel. Revisions to items were made based on their comments. Following revisions, ten cognitive interviews were conducted with adults with coeliac disease across two rounds, with revisions to the questionnaire occurring after each round. Interviews examined cognitive thought processes during questionnaire completion in order to identify sources of response error. Finally, a translatability assessment was undertaken to assess the cultural and linguistic translatability of the questionnaire.

### 3. Item reduction and scale generation

A draft 51-item version of the CDAQ was completed by 412 people with coeliac disease. Nineteen items were

removed following data analysis. A principal components analysis (with Varimax rotation) was conducted on the remaining 32 items, identifying six meaningful dimensions, two of which were merged. Cronbach's alpha values ranged between 0.82 and 0.88 for all dimensions, indicating good internal consistency.

### 4. Evaluation of psychometric properties

The CDAQ was completed by a further 268 people in order to evaluate the psychometric properties of the measure. The final CDAQ contains 32 items addressing the five dimensions below. It measures health-related quality of life using a recall period of the past four weeks.

- stigma (8 items)
- dietary burden (8 items)
- symptoms (5 items)
- social isolation (5 items)
- worries and concerns (6 items).

A study to assess the CDAQ's responsiveness to change is currently underway.

## Scoring System

Dimension scores and an overall index score can be calculated for the CDAQ. Raw scores are transformed to a 0-100 scale, where 0 is the poorest quality of life as measured by the CDAQ, and 100 is the highest quality of life as measured by the CDAQ.

## Apply to use

The CDAQ is managed, as part of a wide portfolio of Patient Reported Outcome measures, by Clinical Outcomes; an activity within the University of Oxford's technology transfer company, Oxford University Innovation Ltd. For further information on how to apply please get in touch via:

healthoutcomes@innovation.ox.ac.uk

+44 (0) 1865 614480



Find out more!



2 translations available



## How are you measuring outcomes in your diabetes studies?

### Background

The Diabetes Health Profile (DHP) is designed to measure the impact of diabetes in a variety of settings from clinical practice to clinical trials. The DHP is simple to complete, acceptable to patients, easy to score, with established validation that delivers interpretable findings.

With its track record and proven performance the DHP is a valuable tool for providing metrics in trial settings.

### Advantages

With proven psychometric and operational performance the Diabetes Health Profile (DHP) has a number of distinct advantages over other diabetes-specific measures of the psychological and behavioural impact of living with diabetes:

- A clearly defined conceptual framework of the measurement model which conforms to the FDA PRO guidance for Industry (2009)
- Content reported by patients as highly relevant to living with diabetes
- The measurement of dysfunctional eating behaviour – which, despite its importance in the management of diabetes, is absent in other scales
- Norm referenced database and MID's
- The use of straight forward language and simple phrasing
- A simple scoring algorithm

### Development

The Diabetes Health Profile (DHP-18) was developed for people with Type 1 and Type 2 diabetes to measure the psychological impact of living with diabetes. It is based on a clearly defined conceptual model and framework, and comprises 18 items which capture the three key domains:-

These are:

- 1 >>> **Psychological distress** - 6-items (dysphoric mood, feelings of hopelessness, irritability)
- 2 >>> **Barriers to activity** - 7-items (perceived limitation to activity, operant anxiety)
- 3 >>> **Disinhibited eating** - 5-items (lack of eating control, response to food cues)

The DHP-18 has been used in community surveys, clinical trials, research studies and educational interventions internationally involving over 15,000 patients. User acceptability of the DHP-18 is high with item completion rates >90%.

The DHP-18 has demonstrated good measurement properties (including reliability coefficient >0.70) and the ability to discriminate between different treatment groups and patient groups experiencing severe hypoglycaemic episodes.

### Apply to use

The DHP is managed, as part of a wide portfolio of Patient Reported Outcome measures, by Clinical Outcomes; an activity within the University of Oxford's technology transfer company, Oxford University Innovation Ltd. For further information on how to apply please get in touch via:

healthoutcomes@innovation.ox.ac.uk

+44 (0) 1865 614417



**New**

Short form (3 + 5 item) utility weighted versions for calculation of QALYs now available!



36 translations available

Find out more!



# The Endometriosis Health Profile (EHP)



Clinical Outcomes

The Endometriosis Health Profile is a Health Related Quality of Life (HRQoL) patient self-report PRO, used to measure the wide range of effects that endometriosis can have on women's lives.

## Background

The EHP is the only condition-specific PRO designed from the patient's perspective to assess health related quality of life in endometriosis. The EHP is available in various formats to suit users study requirements, the long-form core instrument, the EHP-30, the short-form core EHP-5 and a selection of 6 modules that can be used alongside the core instrument.

Published evidence concludes that the EHP is a reliable and valid instrument for assessing areas of concern to women with endometriosis that are not addressed by other condition-specific and generic questionnaires.

The EHP is particularly appropriate for use in clinical trials to assess the effectiveness of medical or surgical therapies for endometriosis on the HRQoL of affected women. For this reason the EHP has been used by four of the top twenty global pharmaceutical companies, supporting numerous clinical trials.

## Modules

The EHP consists of a core instrument, available as either a long-form 30 item instrument (the EHP-30), or the short-form (EHP-5) PRO.

The core instruments have five scale scores covering:

Pain (11)

Control and powerlessness (6)

Social support (4)

Emotional well-being (6)

Self-image (3)

Numbers in brackets represent the number of items in each scale of the (long-form) core EHP-30.

In addition, there is the option of deploying alongside the core instrument six supplementary modules, a total of 23 items (EHP-30 + 23).

These modular scales cover areas of health status that may not affect every endometriosis sufferer and are therefore provided as an option.

## Development

The EHP system including the core and modular scales was developed in a 3 step approach:

### Stage 1 – Item generation.

From qualitative in-depth interviews with 24 women who had laparoscopic diagnosis of endometriosis. This generated a large number (86) of candidate questionnaire items. This 86-item questionnaire was developed and piloted (Group 1) to test basic acceptability and comprehension.

### Stage 2 – Item reduction and scale generation.

A second survey was administered using the 87-item questionnaire to 1000 women from the National Endometriosis Society, U.K. (Group 2). The items were reduced using factor analysis of the survey results to produce a shorter (53-item) questionnaire and enable the most salient dimensions of endometriosis which affect HRQoL to be identified.

### Stage 3 – Establishing test-retest reliability and validity.

To establish test-retest reliability and validity, a third survey was administered to 83 women recruited from an out-patient gynaecology clinic at the John Radcliffe Hospital, Oxford, (Group 3) using the 53-item questionnaire generated at stage 2. Construct validity was assessed in a postal survey (n = 40) to women undergoing conservative surgery for endometriosis at the John Radcliffe Hospital (Group 4) who completed the EHP-30 and SF-36.

## Apply to use

The EHP is managed, as part of a wide portfolio of Patient Reported Outcome measures, by Clinical Outcomes; an activity within the University of Oxford's technology transfer company, Oxford University Innovation Ltd. For further information on how to apply please get in touch via:

healthoutcomes@innovation.ox.ac.uk

+44 (0) 1865 614480



Find out more!



58 translations available

The HASMID- 10 is a measure that determines the impact of self-management in diabetes

## Background

HASMID-10 is a short questionnaire that contains ten items each with four response levels to measure the impact of self-management in diabetes for both Type 1 Diabetes and Type 2 Diabetes.

The measure was developed using a mixed-methods approach that involved semi-structured interviews with people with diabetes. The measure has high face validity. Ongoing research is being undertaken to assess the validity of this questionnaire for measuring the impact of self-management interventions in economic evaluation (**HRQoL**).

## The measure

The HASMID-10 identifies Eight management attributes. The three attributes from the DHP and energy for the attributes designed to capture **HRQoL**, and the four attributes identified from the patient interviews cover self-management, resulting in the following eight attributes for inclusion in the questionnaire.

- 1.Mood
- 2.Hypoglycaemic attacks
- 3.Social Limitations
- 4.Energy
- 5.Control
- 6.Hassle
- 7.Stress
- 8.Support

Four of these self-management attributes (Control, Hassle, Stress + Support) were selected with four health attributes; mood, fear about hypos (hypoglycaemic episodes), energy and social limitations

## Advantages

The HASMID-10 questionnaire is a short, easy-to-complete PROM. It has been developed following a series of rigorous iterations, with high involvement of patients and service-users to ensure good face validity.

- Appears to perform better than EQ-5D-5L
- Ability to differentiate between treatment groups
- Can be scored using total summative scores
- Utility and monetary values are available
- Can be used in a range of applications including cost-utility and cost-benefit analysis

## Apply to use

The HASMID-10 is managed, as part of a wide portfolio of Patient Reported Outcome measures, by Clinical Outcomes; an activity within the University of Oxford's technology transfer company, Oxford University Innovation Ltd. For further information on how to apply for a licence please get in touch via:

healthoutcomes@innovation.ox.ac.uk

+44 (0) 1865 614480



Find out more!

New

Preference-based utility tool used to extract health economic data from the existing HASMID-10, now available!

LUNSERS was developed by researchers within the University of Liverpool to indicate the extent of side-effects experienced by patients medicated with neuroleptic drugs.

## Background

- Present findings indicate that LUNSERS may be a useful tool, as a brief and cost-effective measure of side-effects in research studies
- The scale is completed by the patient and can be easily administered by members of various health care disciplines without specialist training
- LUNSERS assesses a wide range of neuroleptics side-effects
- Patients find the scale to be easy complete within 5-20 minutes
- 'Red-herring' items helped to test the robustness of the results

## Development

The measurement scale consists of 51 items, which were mainly based on adaptations to the physician-rated items in the UKU side effects rating scale. Forty-one items, covering psychological, neurological, autonomic, hormonal and other miscellaneous side-effects, were constructed by rewording the appropriate UKU items, so that they could be self-rated.

In addition, 10 'red herring' items were included, referring to symptoms that are not known neuroleptic side-effects (e.g. chilblains, hair loss), to help validate the results.

In order to assess the validity of the questionnaire the study team has administered it not only to patients being treated with neuroleptics (n=50) but also to normal control subjects (n=50) from which none were receiving psychiatric treatment or medications of any kind.

The LUNSERS was found to be a valid and reliable assessment of patients' experiences of neuroleptic side-effects.

## Scoring

The scale consists of 41 known side effects of neuroleptics. Each 'side-effect' listed is scored on a five point rating scale of 0 - 4, i.e. 0 = 'Not at all' and 4 = Very much. It can be used to provide a general overview of the person's experience to side effects over the last month.

It is useful also in pinpointing specific troublesome side effects for further assessment and / or changes in the medication strategy. Details of the scoring system for the LUNSERS can be downloaded in Dossier Extracts section.

## Apply to use

The LUNSERS is managed, as part of a wide portfolio of Patient Reported Outcome measures, by Clinical Outcomes; an activity within the University of Oxford's technology transfer company, Oxford University Innovation Ltd. For further information on how to apply please get in touch via:

healthoutcomes@innovation.ox.ac.uk

+44 (0) 1865 614480



3 translations available

A substantial number of children and adults have mathematics anxiety, which may severely disrupt their mathematical learning and performance, both by causing avoidance of mathematical activities and by overloading and disrupting working memory during mathematical tasks. Maths anxiety is a relatively frequent phenomenon and often related to dyscalculia.

## Background

A number of research papers lay out the issues of attitudes to and anxiety with mathematics: –

Mathematics depends not only on cognitive abilities but also on emotional factors and attitudes

Emotional factors may play a large part in mathematical performance, with mathematics anxiety playing a particularly large role

Mathematics anxiety might influence performance more directly, by overloading working memory

Relationships between mathematics anxiety and performance may also be in the other direction. Poor mathematical attainment may lead to mathematics anxiety, as a result of repeated experiences of failure, potentially leading to a vicious circle, where anxiety and performance affect each other negatively

Development of mathematics anxiety is likely to be due both to social factors, such as exposure to teachers who themselves suffer from mathematics anxiety, and to pre-existing difficulties in numerical cognition; and that those with initial mathematical difficulties are also likely to be more vulnerable to the negative social influences

Thus, a standardised instrument to detect math anxiety as early as possible and monitor at regular intervals would be useful. The Mathematics Attitudes and Anxiety Questionnaire (MAAQ) has been designed, tested, developed and shown to be a simple to complete assessment of attitudes and anxiety related to the individual (respondents) view of mathematics.

## The PRO

The MAAQ uses age-appropriate, simple to understand, pictorial rating scales to capture the student / child's personal views. The MAAQ is an Interviewer administered questionnaire. Responses are captured during an interview by a teacher, teaching assistant, SEN team member, parent or carer who records the responses. The MAAQ consists of 28 questions, focused on 7 domains of measuring the respondents view of mathematics:

1. maths in general
2. written sums
3. mental sums
4. easy maths
5. difficult maths
6. maths tests and
7. understanding the teacher

Each of the seven domains has 4 questions associated with it. For each domain, children were asked about their:-

- 1) Self-rating ('How good are you?') on a scale consisting of ticks and crosses ('very good' to 'very bad');
- 2) Liking for the items ('How much do you like it?'); on a scale consisting of sweets and wasps ('like very much' to 'hate very much');
- 3) Anxiety about them ('How worried would you feel?') on a scale of facial expressions ('very relaxed' to 'very worried') and
- 4) Unhappiness at poor performance ('How unhappy would you feel if you did badly?') on a scale consisting of faces with frowning or happy faces ('very unhappy' to 'very happy')





# The Mild Cognitive Impairment Questionnaire (MCQ)



Clinical Outcomes

The Mild Cognitive Impairment Questionnaire (MCQ) is a self-report, 13-item PRO developed to assess quality of life (QoL) in people with mild cognitive impairment (MCI).

## Background

The MCQ is the first PRO measure to be developed specifically to assess QoL in people with MCI. The MCQ taps into two domains of patient reported quality of life, namely Emotional Effects (6 items) and Practical Concerns (7 items). The MCQ is available as a self-report measure, but can also be accompanied by an advocate / carer's version (separate 14 items) of the measure.

The development of the MCQ closely followed FDA guidance (on the development of PRO measures for use in supporting label claims, FDA, December 2009) where possible.

The MCQ has been developed so it can be used to assess outcomes following intervention such as cognitive rehabilitation or potential pharmacological therapies for MCI. It is a short, simple assessment tool (taking only about 5 minutes to complete) for use in a variety of clinical and research settings to assess the effect of interventions for people with MCI. The MCQ could theoretically be applied to mild dementia but this application has not been validated yet.

## Development

The MCQ was developed and tested in a comprehensive three stage process:

### Stage 1 – Item generation.

Semi-structured, in-depth interviews were carried out with 23 people recently diagnosed with MCI. A set of preliminary questionnaire items were then discussed with an expert panel and refined to produce a draft questionnaire. The draft questionnaire was then discussed with a focus group of 11 people with MCI resulting in a final draft 17-item questionnaire.

### Stage 2 – Item reduction and scale generation.

A first postal study (n=280, resulting in 146 completed questionnaires) was conducted using the 17 item questionnaire generated at stage one, along with the SF-12 v2 (Mental Health Component Summary Score (MCS) and Physical Component Summary Score (PCS)). The resulting data was analysed to identify any issues with items

122

measuring the same concept and assess internal consistency (using Cronbach's alpha) of each domain. Construct validity of the MCQ was examined by correlation with the SF12 results. Four items were removed because of floor effects. Factor analysis identified two domains of Emotional Effects (irritation/frustration, anxiety, low mood, concern about the future, worry about the reactions of others and worry that their memory problems) and Practical Concerns (worry about: having forgotten things e.g. names, plans or appointments, problems with conversation due to memory difficulties, feeling generally 'slowed down' or less independent and concern about upsetting others).

### Stage 3 – Testing validity.

The construct validity of the MCQ was examined by correlation with the SF-12v2 MCS and PCS and shown to be adequately correlated.

Further information on the design, development and testing of the MCQ is available in the development paper – see key references. The methods used to develop the MCQ were adopted as they have been shown to be effective in the development of similar questionnaires in the past and in many areas are compliant with FDA guidance in the development of PRO measures.

## Scoring

The 13-item MCQ provides scores for each of the 2 domains. Alternatively, the sum of the scores can provide a single figure used to assess the overall health-related quality of life profile of the individual questioned.

## Apply to use

The MCQ is managed, as part of a wide portfolio of Patient Reported Outcome measures, by Clinical Outcomes; an activity within the University of Oxford's technology transfer company, Oxford University Innovation Ltd. For further information on how to apply please get in touch via:

healthoutcomes@innovation.ox.ac.uk

+44 (0) 1865 614480



3 translations available

Find out more!

The Manchester Foot Pain and Disability Index (MFPDI) is a Patient Reported Outcome (PRO) measure developed and validated to measure pain specifically related to a foot disability. The MFPDI is a suitable instrument for assessing the impact of painful foot conditions in community and clinical populations.

## Background

The MFPDI was the first foot related pain measure to incorporate the views of people with known foot problems from the early stages of development. This self-administered PRO has been validated for use among patients of varying levels of disability associated with a specific foot or general medical condition.

The MFPDI was designed and developed by researchers at the University of Manchester

## The PRO

The MFPDI is a self-administered, paper based PRO consisting of 19-items assessing foot pain and disability. The PRO contains three constructs (four subscales) which reflect disabilities associated with foot pain and two additional items relating to work and leisure. The three constructs identified within the MFPDI are:

- Functional limitation (10 items)
- Pain intensity (7 items)
- Personal appearance (2 items)
- Responses are recorded on a three point scale:
  - None of the time
  - On some days
  - On most /every day(s)

## Attributes

### Valid

The MFPDI has been repeatedly shown to demonstrate content, construct and criterion validity amongst people with varying levels of foot problems.

### Reliable

The MFPDI exhibits good internal consistency.

### Sensitive

The MFPDI has demonstrated its ability to discriminate between known groups with varying levels of a foot specific disability within both clinical and population settings.

### Ease of use

The MFPDI is quick and easy to complete, administer and score.

## Example studies

van der Zwaard BC, Elders PJ, Knol DL, Gorter KJ, Peeraer L, van der Windt DA, van der Horst HE. Treatment of forefoot problems in older people: study protocol for a randomised clinical trial comparing podiatric treatment to standardised shoe advice. *J Foot Ankle Res.* 2011 Mar 31;4(1):11.

Roddy E, Muller S, Thomas E. Onset and persistence of disabling foot pain in community-dwelling older adults over a 3-year period: a prospective cohort study. *J Gerontol A Biol Sci Med Sci.* 2011 Apr;66(4):474-80. Epub 2010 Nov 24.

Menz HB, Roddy E, Thomas E, Croft PR. Impact of hallux valgus severity on general and foot-specific health-related quality of life. *Arthritis Care Res (Hoboken).* 2010 Nov 15.

Mickle KJ, Munro BJ, Lord SR, Menz HB, Steele JR. Foot pain, plantar pressures, and falls in older people: a prospective study. *J Am Geriatr Soc.* 2010 Oct;58(10):1936-40.

Menz HB, Tiedemann A, Kwan MM, Plumb K, Lord SR. Foot pain in community-dwelling older people: an evaluation of the Manchester Foot Pain and Disability Index. *Rheumatology (Oxford).* 2006 Jul;45(7):863-7. Epub 2006 Jan 31.

Bowen CJ, Edwards CJ, Hooper L, Dewbury K, Sampson M, Sawyer S, Burrige J, Arden NK. Improvement in symptoms and signs in the forefoot of patients with rheumatoid arthritis treated with anti-TNF therapy. *J Foot Ankle Res.* 2010 Jun 17;3:10.

## Apply to use

The MFPDI is managed, as part of a wide portfolio of Patient Reported Outcome measures, by Clinical Outcomes; an activity within the University of Oxford's technology transfer company, Oxford University Innovation Ltd. For further information on how to apply please get in touch via:

healthoutcomes@innovation.ox.ac.uk



Find out more!



9 translations available



# The Myocardial Infarction Dimensional Assessment Scale (MIDAS)



Clinical Outcomes

The Myocardial Infarction Dimensional Assessment Scale (MIDAS) is a PRO measure developed and validated to specifically measure the health status of individuals who have suffered a myocardial infarction (MI).

## Background

The MIDAS was designed and developed from the collaboration between PRO experts at Oxford (Professor Crispin Jenkinson) and the University of York (Professor David Thompson, now at ACU Melbourne, and Mr Alun Roebuck). The MIDAS was created as existing quality of life instruments lacked sensitivity to change in assessing health status in MI patients.

## The PRO

The 35-item MIDAS was designed and developed to be able to measure dimensions of specific importance to MI patients and be sensitive to change in health status. The resulting MIDAS is applicable to drug development or other interventions, including cardiac rehabilitation. These interventions are known to have an impact on longevity, and yet, until the development of the MIDAS, their impact on health related quality of life, from the patient's perspective, remained unknown.

## Attributes

### Validated

For use in patients in the early recovery period following MI and in the long term.

Sensitive to change in health status

The MIDAS can readily be used to measure the outcome of any therapeutic intervention.

### Reliable

Results show that the MIDAS is highly reliable, both in terms of internal reliability at the patient group level and, given the magnitude of the reliability results, potentially at the individual level.

### Content

The MIDAS contains seven dimensions (physical activity; insecurity; emotional reaction; dependency; diet; concerns over medication; side effects) and so addresses a combination of concerns distinctively associated with MI patients.

### Condition specific

Addresses aspects of MI not covered by generic PROs. 124

## Easy to use

Short and simple in format, so that it is applicable in a wide range of healthcare applications and results in high response rates. Although predominantly used as patient self-complete questionnaire the MIDAS can be interviewer administered.

## Development

The MIDAS was designed and developed using methods consistent with best-practice in PRO instrument development:

1. Literature review,
2. Exploratory in-depth interviews with MI patients, until no new significant themes appeared,
3. Item generation – of a large pool of candidate questionnaire items (48 items),
4. Item reduction and scale generation – A postal survey (410 individuals with MI) was conducted to determine the acceptability of the measure. This step also enabled the development of a shorter, and more practical, instrument with fewer items, as well as the identification of sub-scales within the instrument,
5. Assessment of construct validity – A Follow up survey was undertaken to test the validity of the questionnaire in comparison with the SF-36, two clinical measures of outcome and a physical health assessment by a specialist cardiac nurse.

## Apply to use

The MIDAS is managed, as part of a wide portfolio of Patient Reported Outcome measures, by Clinical Outcomes; an activity within the University of Oxford's technology transfer company, Oxford University Innovation Ltd. For further information on how to apply please get in touch via:

healthoutcomes@innovation.ox.ac.uk

+44 (0) 1865 614480



5 translations available

Find out more!



The Manchester-Oxford Foot Questionnaire (MOXFQ) is a 16-item Patient Reported Outcome (PRO) measure developed and validated for use in studies assessing outcome following foot and/or ankle corrective surgery.

## Background

Foot and ankle surgery accounts for approximately one fifth of orthopaedic practice and has a high level of patient dissatisfaction. The Manchester-Oxford Foot Questionnaire's (MOXFQ's) are 16-item Patient Reported Outcome (PRO) measures developed and validated for use in clinical trials involving foot surgery. These self-administered PROs assesses how foot problems impair health-related quality of life can be completed before and after surgery.

The original MOXFQ (foot) PRO was developed as an outcome measure of hallux valgus (bunions) corrective surgery and has recently been slightly amended and validated for use among patients with a variety of foot or ankle problems. The **MOXFQ (foot)** and the **MOXFQ (foot and ankle)** PROs are available for license through Clinical Outcomes.

The MOXFQ PROs were developed by researchers in the University of Oxford using interviews with patients and partially drawing on a pain related foot disability measure, the Manchester Foot Pain and Disability Index (MFPDI), as a template for item generation and content. The MFPDI is also available through Clinical Outcomes.

## Attributes

1. Valid
2. Reliable
3. Ability to detect change
4. Acceptable
5. Undimensional scaling

The MOXFQ is endorsed by the British Foot and Ankle Society to measure surgical outcome.

## Advantages

The MOXFQ PROs are self-administered, paper based measures consisting of 16-items. The PROs measure three domains:

1. **Walking/standing (7 items)**
2. **Pain (5 items)**
3. **Social interaction (4 items)**

Response options consist of a 5 point Likert scale ranging from no limitation to maximum limitation.

Developers' of the PROs recommend using the MOXFQ (foot) questionnaire for clinical trials that are specifically investigating outcomes of interventions for hallux valgus correction and use of the MOXFQ (foot and ankle) in all other instances. For example, trials of surgery or audits of outcomes involving all other foot or ankle condition (this may include people with hallux valgus).

## Scoring System

Scores for each domain are calculated by summing the responses to each item within a given domain. Raw scores can be converted to a 0-100 metric where 100=most severe. As mentioned above, the domains can also be summed to give a Summary Index score.

## Apply to use

The MOXFQ is managed, as part of a wide portfolio of Patient Reported Outcome measures, by Clinical Outcomes; an activity within the University of Oxford's technology transfer company, Oxford University Innovation Ltd. For further information on how to apply please get in touch via:

healthoutcomes@innovation.ox.ac.uk

+44 (0) 1865 614480



12 translations available

125

Find out more!

# Musculoskeletal Health Questionnaire (MSK-HQ)

The Musculoskeletal Health Questionnaire (MSK-HQ) is a Patient Reported Outcome which has been developed to assess outcomes in patients with a variety of musculoskeletal conditions

## Background

The Musculoskeletal Health Questionnaire (MSK-HQ) is a Patient Reported Outcome which has been developed to assess outcomes in patients with a variety of musculoskeletal conditions. The MSK-HQ has been found to be acceptable to patients, have good internal consistency, convergent validity and excellent test-retest reliability. It can be used to measure the impact of an MSK condition on a patients' health, regardless of the location of the pain and the care the patient is currently receiving.

## Development

The MSK-HQ was co-produced with patients and clinicians to identify aspects of MSK health important to both. A consensus workshop provided initial domains, and individual items were formulated. Stakeholder acceptability was assessed during a second workshop and a candidate MSK-HQ was then taken forward to quantitative testing in physiotherapy and orthopaedic cohorts (n=570).

The Versus Arthritis MSK-HQ contains 14 items and measures the health status in patients with MSK conditions over the past two weeks. MSK-HQ was developed as a collaboration between Keele and Oxford Universities. The development of MSK-HQ was supported by Versus Arthritis and the NHS.

## Scoring

The MSK-HQ is scored on a range of 0-56, with a better score indicating better MSK-HQ health status. In order to calculate the respondents total score, add the numbers next to the box that the respondent has ticked on the questionnaire form. The total of all of these scores, will give the overall result of the MSK-HQ.

## The Instrument

The Arthritis Research UK MSK-HQ contains 14 items and measures the health status in patients with MSK conditions over the past two weeks. There are a number of different dimensions to the instrument:



## Apply to use

The MSK-HQ is managed, as part of a wide portfolio of Patient Reported Outcome measures, by Clinical Outcomes; an activity within the University of Oxford's technology transfer company, Oxford University Innovation Ltd. For further information on how to apply please get in touch via:

healthoutcomes@innovation.ox.ac.uk

+44 (0) 1865 614480



Find out more!



8 translations available

Up to now, no short efficient cognitive screening tool was available that targets stroke survivors. The OCS (Oxford Cognitive Screen) can be delivered at the bedside in acute stroke, is easy to administer and score and is inclusive for patients with aphasia and neglect. It returns a visual snapshot of a patient's cognitive profile which summarizes performance across 5 cognitive domains.

## Background

The Oxford Cognitive Screen brings neuropsychological expertise to cognitive screening in (sub)acute stroke, where long domain specific assessments are not practical due to time and staff pressured environments. The OCS is a short yet informative, domain-specific and Aphasia & Neglect friendly screening tool that particularly picks up and evaluates prevalent post stroke cognitive impairments such as hemispatial neglect, apraxia, and problems in reading and writing.

The OCS, as a domain-specific cognitive screen results in a cognitive profile, highlighting areas of impairment as well as preserved cognitive abilities to give a more informative outcome than an overall 'cognition pass/fail'.

## The PRO

The Oxford Cognitive Screen is a short and efficient cognitive screening tool that can be delivered at the bedside in acute stroke.

The OCS is easy to administer and score and importantly is inclusive for patients with aphasia and neglect. OCS returns a visual snapshot of a patient's cognitive profile, in a 'wheel of cognition', which at a glance demonstrates the specific cognitive domain impairments in:

- Attention
- Language
- Praxis
- Number
- Memory

No specific training outside the manual and online tutorial video is required to administer OCS, though we are happy to help set up local hands-on training courses.

## Development

The OCS was developed, normed and validated at the University of Oxford, the endorsed translations of OCS available adhere to a high standard and have been normed and validated for the targeted population. The OCS is freely available for publicly funded clinical and research use.

## Administration

No courses or specific in person training is required to administer OCS. We recommend reading the manual and scoring guides as well as watching a demonstration video in the first instance that is available on our website.

As with any other assessment, practice makes perfect, and you will improve in fluency and speed, particularly in anticipating the next question/task and being able to move the relevant pages around and swap between the test booklet, the examiner scoring page and the pages for the participant to draw/write on.

## Apply to use

The OCS is managed, as part of a wide portfolio of Patient Reported Outcome measures, by Clinical Outcomes; an activity within the University of Oxford's technology transfer company, Oxford University Innovation Ltd. For further information on how to apply please get in touch via:

healthoutcomes@innovation.ox.ac.uk

+44 (0) 1865 614480

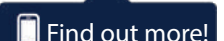

The Oxford Depression Questionnaire (ODQ) is a patient-centred, self-report measure of emotional symptoms present in patients treated with antidepressants.

## Background

Some patients with major depression report a restricted range of emotions that may appear to arise as a side-effect of treatment with antidepressants. It is uncertain whether this phenomenon, sometimes called emotional blunting, represents residual symptoms of depression or side-effects of antidepressant treatment. The Oxford Depression Questionnaire (ODQ) is a patient-centred, self-report measure of emotional symptoms present in patients treated with antidepressants.

The Oxford Depression Questionnaire (ODQ) was formerly called the Oxford Questionnaire on the Emotional Side-Effects of Antidepressants (OQESA).

## The measure

The ODQ is a 26-item patient self-complete measure, spread over 3 sections and covering 4 dimensions (derived from qualitative research) of

1. Not caring (NC)
2. Emotional detachment (ED)
3. Positive reduction (PR)
4. General reduction (GR)

The 3 sections of the ODQ are:

1. 12 items, three items from each of the 4 dimensions (NC, ED, PR and GR). Recall period is the last week.
2. 8 items, 2 from each of the four dimensions, comparing respondents experiences during the previous week with in comparison to their experiences before they developed their illness / problem.
3. 6 items, is for completion by those respondents currently prescribed antidepressants. This section addresses the extent to which participants attribute their emotional difficulties to their antidepressant, and the extent to which they would therefore be considered by participants to be “emotional side-effects”. It also addresses the possible impact of emotional side-effects on antidepressant adherence.

## Advantages

The key characteristics and benefits of the ODQ (based on results acquired during development) are:

### Acceptability

Completion of the questionnaire by patients was extremely high with 96% completing the instrument on 3 separate occasions (weeks 0, 1 and 4)

### Validity

The ODQ has high construct validity with four dimensions (reduction in positive emotions; general reduction in emotions; not caring; and emotional detachment) being represented in the ODQ. In addition, items in the ODQ demonstrate close relationships to contents of other scores measuring emotional blunting.

### Sensitivity to change

When compared to a “gold standard” question (relating to the participant’s experience of emotional side-effects) the ODQ appears to be sensitive to change.

### Reliability

The ODQ has high reliability, both in terms of internal reliability (items within each construct were highly correlated) and test-retest reliability.

## Apply to use

The ODQ is managed, as part of a wide portfolio of Patient Reported Outcome measures, by Clinical Outcomes; an activity within the University of Oxford’s technology transfer company, Oxford University Innovation Ltd. For further information on how to apply for a licence to use the ODQ please get in touch with the Clinical Outcomes team via:

healthoutcomes@innovation.ox.ac.uk

+44 (0) 1865 614417

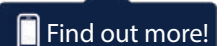

The Oxford Elbow Score (OES) is a short 12-item PRO specifically designed and developed for assessing outcomes of elbow surgery.

## Background

The PRO was designed and developed by researchers within the Health Services Research unit, part of the Nuffield Department of Population Health at the University of Oxford, in association with surgical colleagues at the Nuffield Orthopaedic Centre.

The OES, which is the only patient-reported PRO for elbow surgery in existence, has been tested in a surgical context with patients and shown to be reliable, valid and responsive.

## The PRO

There are 12 questions in the Oxford Elbow Score with three unidimensional domains:

- Elbow function
- Pain
- Social-psychological

Each of the domains comprises 4 items with good measurement properties. Each of the domains/sub-scales was identified by Factor analysis and shown to be unidimensional by Rasch analysis. In addition each scale has been demonstrated to have good internal reliability using Cronbach's alpha.

## Attributes

- A condition-specific PRO designed and developed specifically for use in assessing the outcome of surgical intervention of the elbow;
- Can be used as an indicator for recovery and general improvement in quality of life following surgery on the elbow;
- Shown to be valid, reliable and sensitive to change after rigorous testing;  
Brief and easy to complete resulting in good return rates;
- Can be completed anywhere and delivered by post, making follow-up of large numbers of patients much more feasible (and cheaper) than conducting clinical assessments;

- Easy to interpret scores;
- 3 subscales/domains capture patient views on their elbow and the impact on quality of life;
- Application of the OES could be extended to the assessment of other (non-surgical) forms of therapy, for example physiotherapy.

## Development

The development of the OES was driven by demands for a suitable PRO by orthopaedic surgeons who wished to measure the outcomes of their treatments from the patient's perspective.

## Example studies

The OES is primarily used to assess outcomes of elbow surgery including total elbow replacement and arthroscopic surgery. Other uses of the OES include: Assessment of patient outcomes following alternative non-surgical interventions, including physical therapy, cortisone injections, joint supplements and anti-inflammatory medications

Orthopaedic products companies have used the OES to optimise their products and associated surgical procedures in order to improve patient outcomes from surgeries employing their products

Public and private healthcare providers have used the OES to assess patient outcomes across multiple facilities as a measure of the performance of individual treatment centres, which can be used to identify high-performing centres and to raise standards through sharing best practices

For further information about the measure or how to apply for a licence please get in touch via:

[healthoutcomes@innovation.ox.ac.uk](mailto:healthoutcomes@innovation.ox.ac.uk)



14 translations available

Find out more!

The Oxford Hip Score (OHS) is a short 12-item patient-reported PRO specifically designed and developed to assess function and pain with patients undergoing hip replacement surgery. It is short, reproducible, valid and sensitive to clinically important changes.

## Background

The OHS was designed to be completed by the patient thus minimizing potential bias unwittingly introduced by surgeons when assessing the results themselves.

The PRO was designed and developed by researchers within the Nuffield Department of Population Health at the University of Oxford in association with surgical colleagues at the Nuffield Orthopaedic Centre.

## Development

Prior to the development of the OHS, only crude measures of surgical failure, such as the need to perform revision surgery, had been employed in the assessment of patient outcomes. The development of the OHS was driven by the need to conduct more systematic and accurate monitoring of patient outcomes following THR.

### Formats available:

- Paper
- Telephone administered version

## The PRO

The OHS is a patient self-completion PRO containing 12 questions on activities of daily living. The OHS has been developed and validated specifically to assess function and pain for patients undergoing total hip replacement (THR) surgery. The OHS is the most evaluated hip specific measure available.

## Example studies

The Oxford Knee Score and the Oxford Hip Score (OHS) have been adopted by the UK Department of Health (DoH) for the assessment of approximately 120,000 hip and knee operations which are carried out each year in National Health Service (NHS) hospitals.

Private healthcare providers have also been interested in using the Oxford orthopaedic scores, including the OHS, to develop care pathways that achieve the best possible results for the patients. Nuffield Health (UK) is just one of our user community to obtain benefit from the OHS in this way.

## Attributes

- a simple scoring and summing system provides an overall scale for assessing outcome of hip interventions
- the PRO is completed by the patient, independent of the clinical team/surgeon
- the PRO can be completed anywhere, can be delivered by post to patients' homes or deployed by various electronic platforms such as web or PDA. This makes follow-up of large study populations much more feasible (and cheaper) than conducting clinical assessments, requiring a return visit to the hospital.

## Apply to use

The OHS is managed, as part of a wide portfolio of Patient Reported Outcome measures, by Clinical Outcomes; an activity within the University of Oxford's technology transfer company, Oxford University Innovation Ltd. For further information on how to apply please get in touch via:

healthoutcomes@innovation.ox.ac.uk

+44 (0) 1865 614480



27 translations available

Find out more!

The Oxford Knee Score (OKS) is a 12-item patient-reported PRO specifically designed and developed to assess function and pain after total knee replacement (TKR) surgery (arthroplasty). It is short, reproducible, valid and sensitive to clinically important changes.

## Background

The OKS was designed to be completed by the patient thus minimising potential bias unwittingly introduced by surgeons when assessing the results themselves. The PRO was designed and developed by researchers within Public Health and Primary Health Care at the University of Oxford in association with surgical colleagues at the Nuffield Orthopaedic Centre.

## The PRO

The OKS is a patient self-completion PRO containing 12 questions on activities of daily living. The OKS has been developed and validated specifically to assess function and pain after TKR.

## Attributes

- a simple scoring system provides an overall scale for assessing outcomes of knee interventions
- the PRO is completed by the patient, independent of the clinical team/surgeon
- the PRO can be completed anywhere, can be delivered by post to patients' homes or deployed by various electronic platforms such as web or PDA. This makes follow-up of large study populations much more feasible (and cheaper) than conducting clinical assessments, requiring a return visit to the hospital
- It eliminates interobserver error
- Users have reported extremely good response rates – 98% (Medalla 2009)
- In large scale studies the OKS has been ranked the best disease/site-specific PRO for assessing outcome of knee arthroplasty (Dunbar 2001)

## Development

Similar to the situation with hip replacement, prior to the development of the OKS, only crude measures of surgical failure such as the need to perform revision surgery had been employed in the assessment of patient outcomes.

The development of the OKS was driven by the need to conduct more systematic and accurate monitoring of patient outcomes following TKR. As a relatively short instrument the OKS is particularly appropriate for use by older individuals who most often receive TKR.

### Formats available:

- Paper
- Telephone administered version

## Example study

The Oxford Knee Score and the Oxford Hip Score (OHS) have been adopted by the UK Department of Health (DoH) for the assessment of approximately 120,000 hip and knee operations which are carried out each year in National Health Service (NHS) hospitals.

## Apply to use

The OKS is managed, as part of a wide portfolio of Patient Reported Outcome measures, by Clinical Outcomes; an activity within the University of Oxford's technology transfer company, Oxford University Innovation Ltd. For further information on how to apply please get in touch via:

healthoutcomes@innovation.ox.ac.uk

+44 (0) 1865 614480



46 translations available

Find out more!

Oxford Knee Score – Activity and Participation Questionnaire (OKS-APQ) is an 8-item, patient-reported outcome measure intended as a companion/adjunct to the Oxford Knee Score, for assessing higher levels of activity and (social) participation.

## Background

OKS-APQ was developed by researchers within the Health Services Research unit, part of the Nuffield Department of Population Health, and the Nuffield Department of Orthopaedics, Rheumatology and Musculoskeletal Sciences (NDORMS) at the University of Oxford.

## The PRO

It is a Patient Reported Outcome (PRO) Measure designed and validated to complement the Oxford Knee score as an additional scale. Where the OKS is essentially pain and disability-based, the new questionnaire incorporates important additional issues raised by relatively younger or more active patients. The OKS-APQ is a concise measure, with a single domain.

## Development

### Stage 1 – Item generation

Semi-structured, in-depth interviews were carried out with 26 patients, with osteoarthritis (OA), attending orthopaedic or pre-admission clinics at a regional centre, either under consideration for knee replacement, or already awaiting Total Knee replacement (TKR) or Unicompartmental Knee Replacement (UKR) within the next four weeks, or had undergone TKR or UKR between two and 24 months previously.

A set of preliminary questionnaire items were then discussed with an expert panel and refined to produce a draft questionnaire. The draft questionnaire was then piloted with new patients in clinics in three different formats (all with five category Likert scale), a brief cognitive interview then followed and an independent formal assessment of readability and translatability was also conducted resulting in a draft 17-item questionnaire. alongside the OKS and unlike the latter, is not recommended to be used as a stand-alone instrument.

### Stage 2 and 3 – Item reduction and scale generation; testing scale properties

A first postal study (n=73) was conducted using the 17

132

item questionnaire generated at stage one, along with the Oxford Knee score and the SF-36 generic health questionnaire (Mental Health Component Summary Score (MCS) and Physical Component Summary Score (PCS)). The resulting data was analysed to identify any issues with items and assess internal consistency (using Cronbach's alpha). The formal process of item reduction used Exploratory Factor Analysis (EFA), Confirmatory factor Analysis (CFA) and Rasch analysis. Analyses were revisited to confirm the validity of the measure across methods.

Construct validity of the OKS-APQ was examined by correlation with the OKS, SF-36 and Knee and Functional American Knee Society Scores (AKSS) results. There were nine items removed in total: four items because of the high ceiling effect, another four in order to have clear factor structure (that excludes any item) and one item with more than 10% missing data.

The final eight-item questionnaire seems acceptable to patients, as demonstrated by high response rates (effect size 4.16). It has a high level of internal consistency and no redundant items. The OKS-APQ is designed to be used alongside the OKS and unlike the latter, is not recommended to be used as a stand-alone instrument.

## Scoring system

The OKS-APQ provides a single summed score which reflects the severity of problems that the respondent has with their knee. Details of the scoring system for the OKS-APQ can be downloaded in Dossier Extracts section.

## Apply to use

The OKS is managed, as part of a wide portfolio of Patient Reported Outcome measures, by Clinical Outcomes; an activity within the University of Oxford's technology transfer company, Oxford University Innovation Ltd. For further information please get in touch via:

healthoutcomes@innovation.ox.ac.uk



4 translations available

Find out more!



The Oxford Shoulder Instability Score (OSIS) is a short, 12-item, condition-specific, patient reported outcome (PRO) measure developed and validated for measuring surgical and non-surgical therapeutic outcomes of patients presenting with unidirectional or multi-directional instability of the shoulder.

## Background

The OSIS was designed to be completed by the patient thus minimising potential bias unwittingly introduced by surgeons when assessing the results themselves. The PRO was designed and developed by researchers within Public Health and Primary Health Care at the University of Oxford in association with surgical colleagues at the Nuffield Orthopaedic Centre.

## The PRO

The OSIS is a patient self-completion PRO measure containing 12 questions on activities of daily living particularly relevant to patients exhibiting shoulder instability. The OSIS has been specifically designed to assess outcome of therapy (both surgical and non-surgical) by measuring activities of daily living and pain of patients exhibiting shoulder instability.

## Attributes

- **Short**  
The OSIS is a 12 item uncomplicated questionnaire. It therefore benefits from high completion rates. The OSIS is easy to deploy across diverse healthcare applications.
- **Reliable**  
Published results (see development paper) on patient groups demonstrate the reproducibility and internal consistency of the score.
- **Valid**  
The OSIS has been shown to correlate well with existing related clinical and generic PRO measures.
- **Sensitive to change**  
Effect size for the OSIS is large and results (see development paper) clearly show it outperforms generic PROs, including those with a physical role dimension.
- **Practical**  
Easy to complete and can be given to the patient at clinic or sent by post.

## Development

The OSIS was developed using a multi-stage process, consistent with industry best-practice methods. The OSIS joins a portfolio of well-regarded and widely used orthopaedic PRO measures created by Dr Jill Dawson at the Health Services Research Unit (HSRU) in association with colleagues at the Nuffield Department of Population Health and the Nuffield Department of Orthopaedics, Rheumatology and Musculoskeletal Sciences (NDORMS) at the University of Oxford.

The development of the OSIS was supported by world-leading clinicians at the NDORMS led by Professor Andrew Carr. Professor Carr was elected a fellow of the Academy of Medical Sciences in 2009 and is President elect of the British Elbow and Shoulder Surgery Society.

The items in the OSIS were derived from exploratory interviews rather than from clinical assumptions. Draft versions were tested on patients and the final content only agreed when patients understood it and felt no important items had been omitted. Subsequent testing of the OSIS was conducted on 92 patients exhibiting problems related to instability of the shoulder. Test results from the study of the 92 patients show the OSIS to be reliable, valid and sensitive to change.

## Apply to use

The OSIS is managed, as part of a wide portfolio of Patient Reported Outcome measures, by Clinical Outcomes; an activity within the University of Oxford's technology transfer company, Oxford University Innovation Ltd. For further information on how to apply please get in touch via:

healthoutcomes@innovation.ox.ac.uk

+44 (0) 1865 614480



Find out more!



9 translations available

The Oxford Shoulder Score (OSS) is a 12-item patient-reported PRO specifically designed and developed for assessing outcomes of shoulder surgery e.g. for assessing the impact on patients' quality of life of degenerative conditions such as arthritis and rotator cuff problems.

## Background

The development of the OSS was driven by demands for a suitable PRO by orthopaedic surgeons who wished to measure the outcomes of their treatments from the patient's perspective.

The OSS was designed and developed by researchers (within the Health Services Research unit, part of the Nuffield Department of Population Health at the University of Oxford) who also created the Oxford Hip and Knee scores, which are used for assessment of all NHS hip and knee surgeries (approximately 120,000) since April 2009. Designed and developed in association with surgical colleagues at the Nuffield Orthopaedic Centre the OSS has been tested in a surgical context with patients and shown to be reliable, valid and responsive.

First published in 1996, the OSS has gradually been adopted as an outcome measure and is now widely used in clinical studies.

## The PRO

The Oxford Shoulder Score is a unidimensional score comprising 12 questions. A single score is derived from the PRO. Substantial evidence from clinical studies shows that the PRO has high internal consistency and is a valid and reliable measure of patient well-being.

## Attributes

- the only condition-specific PRO designed and developed for use in assessing surgery intervention of the shoulder;
- has undergone rigorous testing for validity, reliability and sensitivity to change and has been shown to be a robust tool for assessing the outcome of shoulder surgery;
- can be employed in surveys or clinical trials for shoulder surgery patient groups;

- the only condition-specific PRO designed and developed for use in assessing surgery intervention of the shoulder;
- has undergone rigorous testing for validity, reliability and sensitivity to change and has been shown to be a robust tool for assessing the outcome of shoulder surgery;
- can be employed in surveys or clinical trials for shoulder surgery patient groups;
- has been shown to be highly responsive to interventions and can be used as an indicator for recovery and general improvement in quality of life following shoulder surgery;
- brief and easy to complete resulting in good return rates;
- the PRO can be completed anywhere and delivered by post/electronically, making follow-up of large numbers of patients much more feasible (and cheaper) than conducting clinical assessments;
- easy to interpret scores.

## Apply to use

The OSS is managed, as part of a wide portfolio of Patient Reported Outcome measures, by Clinical Outcomes; an activity within the University of Oxford's technology transfer company, Oxford University Innovation Ltd. For further information on how to apply please get in touch via:

healthoutcomes@innovation.ox.ac.uk  
+44 (0) 1865 614480



Find out more!

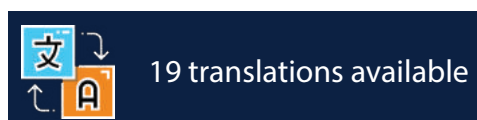

The Oxford Ankle Foot Questionnaire for Children (OxAFQ-C) is a child – or parent (proxy)-reported self-report health status PRO.

## Background

The The Oxford Ankle Foot Questionnaire for Children (OxAFQ-C) is used to measure subjective well-being for child patients (aged 5-16) affected by foot and ankle conditions using issues that are considered important to children.

Typical clinical assessments fail to capture the child patient's perspective and may not accurately reflect how children function in their usual environments. The OxAFQ-C was therefore designed to supplement clinical assessments to evaluate the effectiveness of interventions for ankle/foot problems in children.

## The PRO

The The Oxford Ankle Foot Questionnaire for Children (OxAFQ-C) is used to measure subjective well-being for child patients (aged 5-16) affected by foot and ankle conditions using issues that are considered important to children.

Typical clinical assessments fail to capture the child patient's perspective and may not accurately reflect how children function in their usual environments. The

## Attributes

- The OxAFQ-C is rapidly gaining acceptance as the PRO of choice for assessing the impact of ankle/foot conditions in children for the following reasons:
- It is the only PRO available assessing the impact of ankle foot issues on children from both the child and parent/-caregivers perspective;
- The OxAFQ-C has broad utility both in routine clinical settings or applied research comparing different treatment programmes used in paediatric orthopaedics, trauma and rheumatology;
- A short (15-item) questionnaire that has proven to be easy to complete and returns high completion rates; Has been proven to be a valid and reliable (Morris et al 2008, see reference below) as well as being responsive and longitudinally valid (Morris et al 2009).

135

## Development

Ox-PAQ items, which had previously been informed using the nine chapters of the ICF, 41 patient interviews, expert reviews and 13 cognitive interviews, were administered by postal survey to 386 people with three neurological conditions; Parkinson's disease, amyotrophic lateral sclerosis, and multiple sclerosis. Participants also completed the MOS 36-Item Short Form Survey (SF-36) and EQ-5D-5L. Consenting participants were also sent the OxPAQ items to complete again after a period of two weeks.

162 men and 172 women completed the survey achieving a response rate of 86.5%. The mean age of the sample was 60.06 years (SD 12.10).

Ox-PAQ domains

Routine Activities (14 items), assesses individuals' capacity to engage in regular activities that form the basis of daily life.

Emotional Well-Being (5 items), gives an indication of current mental health status.

Social Engagement (4 items), reflects how well, or otherwise, individuals are able to maintain relationships, both personal and from a wider community perspective.

## Apply to use

The OxAFQ-C is managed, as part of a wide portfolio of Patient Reported Outcome measures, by Clinical Outcomes; an activity within the University of Oxford's technology transfer company, Oxford University Innovation Ltd. For further information on how to apply please get in touch via:

healthoutcomes@innovation.ox.ac.uk

+44 (0) 1865 614480



7 translations available



Find out more!



# The Oxford Participation and Activities Questionnaire (Ox-PAQ)



Clinical Outcomes

The Oxford Participation and Activities Questionnaire is a short, 23-item, patient-reported outcome measure developed to assess participation and activity in patients experiencing a range of health conditions.

## Background

There is growing interest in the management of long-term conditions and keeping people active and participating in daily life (1-4). Testing the effectiveness of interventions which aim to impact upon activities and participation, however, can be challenging without the availability of a well-developed, valid and reliable instrument.

The Oxford Participation and Activities Questionnaire is a patient-reported outcome measure that is grounded on the World Health Organization International Classification of Functioning, Disability, and Health (ICF) and is fully compliant with current best practice guidelines, such as those published by the FDA.

The Ox-PAQ was developed by researchers within the Health Services Research Unit, part of the Nuffield Department of Population Health at the University of Oxford.

The Ox-PAQ also comes as an 'acute' version, with emphasis on the recall period being more recent; 1 week rather than 4 weeks.

The development of the OxPAQ was funded by the European Brain Council.

## Validation

The primary use of the Ox-PAQ is intended to be in clinical trials and related forms of evaluation of interventions targeted at maintaining activity and participation.

Further work by the OxPAQ development team at the University of Oxford, has resulted in the populations that the OxPAQ is validated for being extended to include:

- Chronic Obstructive Pulmonary Disease (COPD)
- Aneurysmal Subarachnoid Haemorrhage (SAH)
- Valvular heart disease.

## Development

Ox-PAQ items, which had previously been informed using the nine chapters of the ICF, 41 patient interviews, expert reviews and 13 cognitive interviews, were administered by postal survey to 386 people with three neurological conditions; Parkinson's disease, amyotrophic lateral sclerosis, and multiple sclerosis. Participants also completed the MOS 36-Item Short Form Survey (SF-36) and EQ-5D-5L. Consenting participants were also sent the OxPAQ items to complete again after a period of two weeks.

162 men and 172 women completed the survey achieving a response rate of 86.5%. The mean age of the sample was 60.06 years (SD 12.10).

Ox-PAQ domains

Routine Activities (14 items), assesses individuals' capacity to engage in regular activities that form the basis of daily life.

Emotional Well-Being (5 items), gives an indication of current mental health status.

Social Engagement (4 items), reflects how well, or otherwise, individuals are able to maintain relationships, both personal and from a wider community perspective.

## Apply to use

The Ox-PAQ is managed, as part of a wide portfolio of Patient Reported Outcome measures, by Clinical Outcomes; an activity within the University of Oxford's technology transfer company, Oxford University Innovation Ltd. For further information on how to apply please get in touch via:

healthoutcomes@innovation.ox.ac.uk

+44 (0) 1865 614480



25 translations available

Find out more!



# The Parkinson's Disease Questionnaire (PDQ)



Clinical Outcomes

Enhance your value proposition with the gold-standard Patient Reported Outcome (PRO) measure for Parkinson's Disease: the PDQ

## Background

Substantial evidence is available to suggest that the PDQ is reliable, valid, responsive, acceptable and feasible as the tool for the assessment of quality of life in Parkinson's disease patients. For these reasons it has been widely adopted and generally considered the industry 'gold standard'.

The PDQ is primarily used in clinical trials of therapeutics intended to benefit individuals with Parkinson's disease.

The PDQ is the most comprehensive Parkinson's disease assessment questionnaire because it is:

- simple to complete so benefits from an excellent response rate
- proven by validation and feasibility studies (reported in the manual) covering topics such as cross-cultural evaluation
- supported by a comprehensive 114 page user manual
- available in over 80 language versions
- available in the core PDQ-39 (39 items) or the short form PDQ-8 (8 items), it can be supported by expert advice available from the developers for the use, delivery and data assessment of the PDQ.

## PDQ Users

The PDQ has been used to support more than 150 clinical trials, involving more than 20,000 patients, including many of the world's largest pharmaceutical companies:



## Development

All key Parkinson's Disease health status issues were captured by in-depth interviewing of patients.

Questionnaire items constructed from the interviews cover eight discrete scales:

- mobility
- activities of daily living
- emotional well-being
- stigma
- social support
- cognitions
- communication
- bodily discomfort

The PDQ is highly responsive to intervention efficacy, regardless of the mechanism of action – it has been used to assess patient outcomes in trials employing drug, surgical (e.g. Deep Brain Stimulation) and alternative therapies.

## Modules

Also available to licence is the PDQ-Carer, a 29-item measure of health related quality of life for use with carers of people with Parkinson's disease. New validation work is planned for the following modules:

- PDQ-Sleep
- PDQ-Exercise
- PDQ-Medication

## Apply to use

The PDQ is managed, as part of a wide portfolio of Patient Reported Outcome measures, by Clinical Outcomes; an activity within the University of Oxford's technology transfer company, Oxford University Innovation Ltd. For further information on how to apply please get in touch via:

healthoutcomes@innovation.ox.ac.uk

+44 (0) 1865 614480

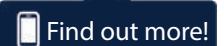
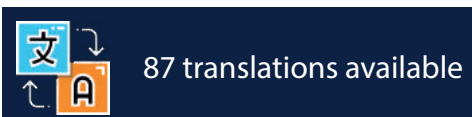



# Parkinson's Disease Questionnaire – Carers (PDQ-Carer)



Clinical Outcomes

The Parkinson's Disease Questionnaire-Carer (PDQ-Carer) is the first well documented, simple scoring measure of quality of life among this population.

## Background

Carers can be an important source of help and support to people with long term conditions, such as Parkinson's disease (PD). Carers for people with PD can face numerous responsibilities arising from the need to provide support and assistance to a person they care for. This is particularly important for those caring for a person with a progressively disabling disease which can have direct implications upon their quality of life.

The Parkinson's Disease Questionnaire-Carer (PDQ-Carer) is the first well documented, simple scoring measure of quality of life among this population. Consistent with best practice, the developers of the PDQ-Carer have incorporated the views of carers of people with PD throughout the PROs development.

The PDQ-Carer was developed by researchers in the University of Oxford who are responsible for the development of the Parkinson's Disease Questionnaire-39 (PDQ-39) (also available through our clinical outcomes team). The PDQ-39 is the most widely

## Attributes

### Valid

The PDQ- Carer demonstrates good content and construct validity.

### Reliable

The PDQ- Carer exhibits good internal consistency.

### Acceptable

Pre-testing and high completion rates suggest that the PDQ-Carer is easy to complete and acceptable within the test population.

### Easy to administer

The PDQ-Carer is a self-administered, paper based PRO. It is both short and easy to score.

### Can be used with the developers' corresponding patient questionnaire (the PDQ-39)

The PDQ-Carer can be used in conjunction with the established PDQ-39 to allow test administrators to correlate quality of life scores of a person with PD and their respective carer.

## The PRO

There are 29 items in the PDQ-Carer, representing four discrete scales:

- Social and personal activities (12 items)
- Anxiety and depression (6 items)
- Self-care (5 items)
- Stress (6 items)

The PRO asks about the influence of caring on specific areas of life over the past four weeks. Respondents are asked to select one of five response options: Never/Occasionally/Sometimes/Often/Always.

## Scoring system

The PDQ-Carer benefits from a simple scoring system. The raw score of each scale can be calculated and converted to a 0-100 metric where 0=no problem at all and 100=worst or maximum level of problem. The sum of the scale scores can provide a single figure used to assess the overall quality of life of the individual questioned.

## Apply to use

The PDQ0-C is managed, as part of a wide portfolio of Patient Reported Outcome measures, by Clinical Outcomes; an activity within the University of Oxford's technology transfer company, Oxford University Innovation Ltd. For further information on how to apply please get in touch via:

healthoutcomes@innovation.ox.ac.uk

+44 (0) 1865 614480



Find out more!



4 translations available

# Recovering Quality of Life (ReQoL) Questionnaire

The Recovering Quality of Life (ReQoL) is a Patient Reported Outcome which has been developed to assess the quality of life for people with different mental health conditions.

## Background

ReQoL is a brief outcome measure focusing on the process of recovery for users of mental health services. Developed by a team at The University of Sheffield to capture the concerns of service users on their quality of life. This work was commissioned and funded by the Department of Health Policy Research Programme in England for use in the NHS.

## Development

In the development of ReQoL, qualitative and quantitative techniques were implemented to produce a psychometrically robust measure using inputs from service users with a broad range of mental health diagnoses and severity. A significant contribution was received, at all stages, from governance groups including a stakeholder group, an advisory group, a scientific group, clinicians, and an expert user group.

## Advantages

Comprehensive psychometric testing has shown that the ReQoL is:

Valid for a population with mental health conditions



Straightforward to score and interpret



Face and content validity with service users and clinicians



Further work is planned to generate preference weights for the ReQoL. These can be used to calculate quality adjusted life years (QALYs) for use in economic evaluation of health care interventions



Easy to complete



Considerable inputs of service users in the design and item selection



## The Instrument

ReQoL has two versions: a brief 10-item measure (ReQoL-10), and a 20-item measure (ReQoL-20). The ReQoL measures are generic and can be used across all mental health populations including common mental health problems, severe and complex, and psychotic disorders. They are suitable for mental health populations aged 16 and over in primary, secondary, and tertiary care.

There are seven themes captured by ReQoL, and these themes overlap and are not mutually exclusive:



## Apply to use

The ReQoL is managed, as part of a wide portfolio of Patient Reported Outcome measures, by Clinical Outcomes; an activity within the University of Oxford's technology transfer company, Oxford University Innovation Ltd. For further information on how to apply for a licence to use the ReQoL, please get in touch via:

healthoutcomes@innovation.ox.ac.uk

+44 (0) 1865 614480



Find out more!



17 translations available